



HAL
open science

Cytokine Receptor-independent, Constitutively Active Variants of STAT5

Susanne Berchtold, Richard Moriggl, Fabrice Gouilleux, Olli Silvennoinen, Christian Beisenherz, Edith Pfitzner, Manuela Wissler, Elisabeth Stöcklin, Bernd Groner

► **To cite this version:**

Susanne Berchtold, Richard Moriggl, Fabrice Gouilleux, Olli Silvennoinen, Christian Beisenherz, et al.. Cytokine Receptor-independent, Constitutively Active Variants of STAT5. *Journal of Biological Chemistry*, 1997, 272 (48), pp.30237-30243. 10.1074/jbc.272.48.30237 . hal-02427402

HAL Id: hal-02427402

<https://univ-tours.hal.science/hal-02427402>

Submitted on 1 Nov 2021

HAL is a multi-disciplinary open access archive for the deposit and dissemination of scientific research documents, whether they are published or not. The documents may come from teaching and research institutions in France or abroad, or from public or private research centers.

L'archive ouverte pluridisciplinaire **HAL**, est destinée au dépôt et à la diffusion de documents scientifiques de niveau recherche, publiés ou non, émanant des établissements d'enseignement et de recherche français ou étrangers, des laboratoires publics ou privés.

Cytokine Receptor-independent, Constitutively Active Variants of STAT5*

(Received for publication, August 27, 1997, and in revised form, September 22, 1997)

Susanne Berchtold‡, Richard Moriggl‡, Fabrice Gouilleux§, Olli Silvennoinen¶, Christian Beisenherz‡, Edith Pfitzner‡, Manuela Wissler‡, Elisabeth Stöcklin‡, and Bernd Groner‡||

From the ‡Institute for Experimental Cancer Research, Tumor Biology Center, Breisacher Strasse 117, D-79106 Freiburg, Germany, §Institut Cochin de Génétique Moléculaire, Unité INSERM U363, Hôpital Cochin, 27, rue Faubourg St. Jacques, 75014 Paris, France, and the ¶Institute of Medical Technology, University of Tampere, 33101 Tampere, Finland

STAT (signal transducers and activators of transcription) proteins are dual function proteins, which participate in cytokine-mediated signal transduction events at the cell surface and transcriptional regulation in the nucleus. We have exploited insights into the activation mechanism of STAT factors to derive constitutively active variants. Chimeric genes encoding fusion proteins of STAT5 and the kinase domain of JAK2 have been derived. The functional properties of the fusion proteins have been investigated in transiently transfected COS cells or in HeLa cells stably transfected with STAT5-JAK2 gene constructs regulated by a tetracycline-sensitive promoter. The STAT5-JAK2 proteins exhibit tyrosine kinase activity and are phosphorylated on tyrosine. The molecules are activated through an intramolecular or a cross-phosphorylation reaction and exhibit constitutive, STAT5-specific DNA binding activity. The transactivation potentials of three constitutively activated STAT5-JAK2 variants comprising different transactivation domains (TADs) derived from STAT5, STAT6, and VP16 were compared. The chimeric molecule containing the STAT5 TAD had no or only a very low, the molecule with the STAT6 TAD a medium, and the molecule with the VP16 TAD a very high transactivation potential. Transcription from STAT5-responsive gene promoter regions of the β -casein, oncostatin M, and the cytokine-inducible Src homology 2 domain-containing protein genes was observed. These chimeric STAT molecules allow the study of the function of STAT5 independent of cytokine receptors and the activation of other signal transduction pathways.

Growth factor receptors and cytokine receptors share functional features in their regulation of cell survival, control of proliferation, and differentiation. Although structurally distinct, they commonly utilize molecular components in signal transduction events (1, 2). Both families of receptors are dimerized by the binding of extracellular ligands, which cause the activation of cytoplasmic tyrosine kinases. Tyrosine kinase activities are intrinsic to the intracellular domains of growth factor receptors and non-covalently associated with intracellular regions of cytokine receptors. Phosphorylation of these regions of the receptors is thought to generate binding sites for

cytoplasmic signaling components with SH2¹ domains. These molecules become substrates for the tyrosine kinases, and phosphorylation causes a switch from a latent into an active form. The activation of the MAP kinase pathway via the adaptor protein Grb2, the Ras guanine nucleotide-releasing factor Sos, the accumulation of active Ras-GTP, and the recruitment of active c-Raf to the membrane has been observed upon growth factor receptor treatment of cells (e.g. with EGF or platelet-derived growth factor) or cytokine treatment of cells (e.g. with IL-2 or prolactin) expressing the corresponding receptors. The same is true for other signaling components like phosphoinositol 3-kinase, phospholipase C γ , Src kinase family members, SH2 domain-containing phosphotyrosine phosphatases, and signal transducers and activators of transcription (STAT) factors (3–6).

The simultaneous activation of different signal transduction pathways by a single signal (growth factor or cytokine) and its corresponding receptor, makes it difficult to assign a particular contribution of an individual signaling component or pathway to the ultimate effect on the cells. To dissect the contributions of individual signal transduction components to the cellular phenotypes induced by growth factors and cytokines, several strategies have been employed. These strategies aim at the prevention of activation of one particular signaling molecule, while preserving all the others. For this purpose, homologous recombination has been used to inactivate the genes encoding signaling components and knock-out mice have been analyzed (e.g. Ref.7); the tyrosine residues within the docking sites of SH2-containing signaling molecules in the intracellular domain of receptors have been mutated (e.g. Ref. 8), and dominant negative variants of signaling molecules have been derived (9).

STAT5 was originally discovered as a transcription factor, which mediates the prolactin response in mammary epithelial cells. It is essential for the transcriptional induction of milk protein genes (10–12). Meanwhile, it has been found that MGF-Stat5 is also activated by other hormones and cytokines, e.g. IL-2, IL-7, and IL-15 (13); IL-3, IL-5, and granulocyte/macrophage colony-stimulating factor (14); erythropoietin (15); growth hormone (16); thrombopoietin (17); and EGF (18). STAT5 has been implicated in the regulation of genes that are important for the prevention of apoptosis and proliferation in hematopoietic cells (19). We have devised a strategy to gain

* The costs of publication of this article were defrayed in part by the payment of page charges. This article must therefore be hereby marked "advertisement" in accordance with 18 U.S.C. Section 1734 solely to indicate this fact.

|| To whom correspondence should be addressed: Institute for Experimental Cancer Research, Tumor Biology Center, Breisacher Str. 117, D-79106 Freiburg, Germany. Tel.: 49-761-206-1600; Fax: 49-761-206-1699; E-mail: groner@tumorbio.uni-freiburg.de.

¹ The abbreviations used are: SH2, Src homology 2 domain; MAP, mitogen-activated protein; MAPK, MAP kinase; EGF, epidermal growth factor; IL, interleukin; STAT, signal transducers and activators of transcription; OSM, oncostatin M; CIS, cytokine-inducible SH2-containing protein; TAD, transactivation domain; PCR, polymerase chain reaction; tTA, tetracycline-controlled transactivator; MGF, mammary gland factor; ERK, extracellular signal regulated kinase.

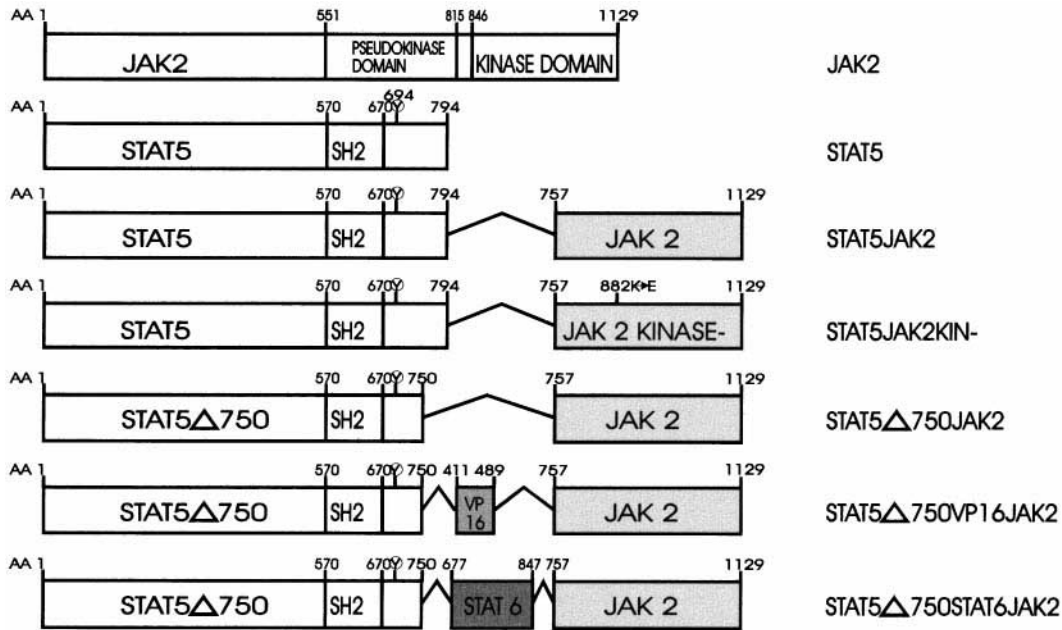

FIG. 1. Structure of JAK2, STAT5, and STAT5-JAK2 fusion proteins. Line 1, JAK2 (Janus kinase 2). The functional domains, pseudokinase domain and kinase domain, are indicated. Line 2, STAT5. The SH2 domain and tyrosine 694, whose phosphorylation is essential for activation, are indicated. The carboxyl-terminal region of STAT5 (amino acids 750–794) has been identified as a transactivation domain. Line 3, STAT5JAK2. The kinase domain of JAK2 (amino acids 757–1129) has been fused to the carboxyl-terminal end of the full-length STAT5 molecule. Line 4, STAT5JAK2KIN⁻. The structure is similar to the one described in line 3, but a kinase-deficient, mutated version of the JAK2 kinase domain (K882E) was used. Line 5, STAT5 Δ 750JAK2. The STAT5 part of the molecule has been truncated at amino acid position 750 and does not include the transactivation domain. Line 6, STAT5 Δ 750VP16JAK2. The transactivation domain of STAT5 was removed and replaced by the TAD of the herpes viral protein VP16 (amino acid positions 411–489). Line 7, STAT5 Δ 750STAT6JAK2. The transactivation domain of STAT5 was removed and replaced by the TAD of STAT6 (amino acid positions 677–847).

insights into the contribution of the STAT5 transcription factor to cellular phenotypes. This will allow study of its function independent from upstream activation events. For this purpose, we have derived constitutively active variants of STAT5, which are able to induce transcription from STAT5-dependent gene promoters.

EXPERIMENTAL PROCEDURES

Construction of STAT-Janus Protein Kinase (JAK) Fusion Genes—To construct the chimeric genes, the region comprising amino acids 613–794 of STAT5 was amplified by a PCR reaction. An *EcoRI* site was introduced at the 3' end of the fragment. The region comprising amino acids 757–1129 of the JAK2 gene was amplified by PCR, and an *EcoRI* site was introduced at the 5' end. Both fragments were joined in a tri-fragment ligation into pBluescriptSK⁺. A *KpnI-NotI* fragment of pXM-MGF(STAT5) (12), comprising amino acids 613–794, was then replaced by the STAT5JAK2 fusion fragment. STAT5 Δ 750JAK2 was cloned in an analogous way. The *EcoRI* site was introduced 3' of amino acid position 750. To obtain STAT5 Δ 750VP16JAK2, the region comprising amino acids 411–489 of VP16 gene was amplified by PCR. *EcoRI* sites were added to both ends. The *EcoRI* fragment was inserted between the STAT5 and the JAK2 parts. The region comprising amino acid positions 677–847 of the STAT6 gene was also amplified by PCR and inserted as an *EcoRI* fragment as described above. To obtain the tetracycline-regulated plasmid p10/3 STAT5 Δ 750VP16JAK2, STAT5 Δ 750JAK2 was subcloned as a blunt-ended *SalI-NotI* fragment into the blunt-ended *NotI* site of pBluescript SK⁺. The fusion gene was then inserted as a *SacII-XbaI* fragment into p10/3 (20), in which transcription is regulated by a tetracycline-controlled transactivator, tTA. p10/3 STAT5 Δ 750STAT6JAK2 was cloned analogously.

Expression of STAT-JAK Fusion Genes in Transfected Cells—COS-7 cells were grown and prepared for transfection as described before (21). Transfection experiments were performed using the calcium phosphate precipitation technique. Semiconfluent COS-7 cells in 10-cm dishes were transfected with 2 μ g of the expression plasmid encoding STAT5 or the STAT5-JAK2 fusion proteins. After 48 h, the cells were lysed. Immunoprecipitation was carried out with a JAK2-specific antibody (Santa Cruz Biotechnology, Inc., Heidelberg, Germany). The immunocomplexes were isolated with protein A-Sepharose, fractionated by SDS-polyacrylamide gel electrophoresis, and blotted onto nitrocellulose. The filters were developed with an antibody specific for JAK2, and the

immunoreactive bands were visualized using an epi-chemiluminescence Western blotting system (Amersham, Braunschweig, Germany). HeLa cells stably expressing the transactivator tTA1 (20) were transfected with the plasmids pBSpac Δ p encoding a puromycin resistance gene and p10/3 STAT5 Δ 750VP16JAK2 or p10/3 STAT5 Δ 750STAT6JAK2. Cells were cultured in the presence of tetracycline (1 μ g/ml) and puromycin (1.25 μ g/ml), and stably transfected cell clones were selected. The expression of the fusion proteins in puromycin-resistant clones was induced by the withdrawal of tetracycline for 48 h and measured by Western blotting and bandshift assays.

Kinase Activity of STAT-JAK Fusion Proteins—The immunocomplexes from transfected COS cells were used for *in vitro* kinase reactions. Immunoprecipitates were incubated in 30 μ l of kinase buffer (50 mM NaCl, 5 mM MgCl₂, 5 mM MnCl₂, 0.1 mM Na₃VO₄, 10 mM Hepes pH 7.4, 10 μ M ATP) in the presence of 1 μ Ci of [γ -³²P]ATP. Kinase reactions were performed for 30 min at room temperature. The *in vitro* phosphorylated proteins were separated by SDS-polyacrylamide gel electrophoresis and visualized by autoradiography.

Electrophoretic Mobility Shift Assays—Whole cell extracts were prepared from cells transfected with the expression vectors encoding the STAT5-JAK2 fusion proteins, and bandshift assays were performed as described (22). The MGF-STAT5 binding site of the bovine β -casein promoter was used as a probe (5'-AGATTTCTAGGAATTCATC-3'). This oligonucleotide was end-labeled with polynucleotide kinase to a specific activity of 8000 cpm/fmol. For competition experiments, unlabeled or mutant (5'-AGATTTCTATTAATTCATC-3') oligonucleotides were added to the binding reaction.

MAP Kinase Assay—HeLa cells transfected with p10/3 STAT5 Δ 750VP16JAK2 were withdrawn from tetracycline for 48 h, treated or not with 30 ng/ml EGF for 5 min, and lysed in ERK lysis buffer (50 mM β -sodium-glycerophosphate, 1.5 mM EGTA, pH 8.5, 2 mM Na₃VO₄, 1 mM dithiothreitol, 2 μ g/ml leupeptin, 2 μ g/ml aprotinin, 1 mM benzamide, 1% Nonidet P-40). The lysates were immunoprecipitated with an ERK2-specific antibody (Santa Cruz). The immunocomplexes were isolated with protein A-Sepharose and washed three times with ERK lysis buffer and once with kinase buffer (30 mM Tris, pH 8.0, 20 mM MgCl₂, 2 mM MnCl₂). The kinase reaction was performed for 30 min at 37 °C in kinase buffer in the presence of 10 μ M ATP, 0.1 μ Ci of [γ -³²P]ATP, and 15 μ g of myelin basic protein as a substrate. The *in vitro* phosphorylated proteins were separated by SDS-gel electrophoresis and visualized by autoradiography.

β-Galactosidase and Luciferase Activity Assays—COS cells were transfected with the expression vectors encoding the STAT5-JAK2 fusion proteins; 2 μg of the β-casein luciferase reporter construct and 2 μg of pHM75 encoding the β-galactosidase gene driven by the cytomegalovirus promoter to normalize for transfection efficiency were included. HeLa cells were transfected with the reporter genes only. Luciferase assays and β-galactosidase assays were performed as described (21).

RESULTS

Construction of STAT-JAK Fusion Genes—We exploited insights into the structure and the activation mechanism of STAT proteins to derive constitutively active variants. STAT proteins are able to bind to phosphotyrosine-containing docking sites in the intracellular domains of cytokine receptors, where they are phosphorylated by receptor-associated JAKs. It is thought that STAT phosphorylation results in the dissociation from the receptor, the formation of homodimers, translocation to the nucleus, binding to specific DNA response elements in the promoter of target genes, and activation of transcription (23–25).

JAK2, a kinase associated with the membrane-proximal region of the intracellular part of, *e.g.* the prolactin receptor, has been shown to be able to phosphorylate STAT5 *in vitro* and *in vivo* (21). JAK2 is structurally well defined (Fig. 1). It comprises 1129 amino acids and consists of a carboxyl-terminal catalytic tyrosine kinase domain (domain 1), a kinase-like domain (domain 2), and an amino-terminal sequence with common subdomains of the JAK gene family (26, 27). It has been shown that the kinase domain of JAK2 is sufficient for signal transduction when fused to the extracellular and transmembrane region of the EGF or growth hormone receptors (28, 29).

The structures of MGF-STAT5, the sheep homologue, and of STAT5a and STAT5b, the mouse homologues (30), have also been investigated (Fig. 1). It has been found that the activation of MGF-STAT5 requires the phosphorylation of tyrosine residue 694 by JAK2 (21) and that the 50 carboxyl-terminal amino acids comprise the transactivation domain of the molecule (9). To derive constitutively activated STAT5 variants, we constructed fusion proteins consisting of MGF-STAT5 (794 amino acids) and the tyrosine kinase domain of JAK2 (373 amino acids, position 757–1129). We fused the kinase domain of JAK2 to the carboxyl terminus of MGF-STAT5 (STAT5JAK2) (Fig. 1). Since we have previously observed that the transactivation domain of MGF-STAT5 is relatively weak, we also derived constructs in which the STAT5 transactivation domain has been replaced by the transactivation domain of STAT6 (STAT5Δ750STAT6JAK2) or by VP16 (STAT5Δ750VP16JAK2). Constructs that lack a transactivation domain (STAT5Δ750JAK2) or that comprise an enzymatically inactive kinase domain (STAT5JAK2KIN⁻) served as controls. The constructs were integrated in vectors (pXM) that allow constitutive expression in transiently transfected COS cells or in vectors (p10/3) that provide for conditional regulation by a tetracycline-dependent transactivator.

Expression of the STAT-JAK Fusion Proteins in COS7 Cells and Measurement of Kinase Activities—To investigate the expression and the enzymatic properties of these fusion proteins, the chimeric constructs were integrated into the eukaryotic expression vector pXM and transfected into COS-7 cells. Cell lysates were prepared, and the fusion proteins were precipitated with a JAK2-specific antiserum and analyzed by Western blotting (Fig. 2A). Proteins of the expected sizes (JAK2 of 124 kDa, lane 2; STAT5JAK2 of 128 kDa, lane 3; STAT5Δ750VP16JAK2 of 132 kDa, lane 4; STAT5Δ750STAT6JAK2 of 142 kDa, lane 5; STAT5Δ750JAK2 of 123 kDa, lane 6) were found. To test the kinase activities of these fusion proteins, an *in vitro* kinase assay was performed. The immunoprecipitated proteins were incubated with [γ -³²P]ATP and analyzed by SDS-gel electrophoresis and au-

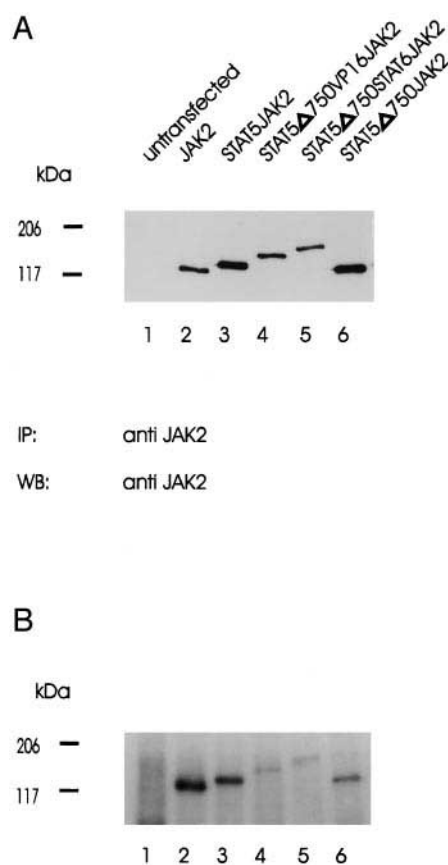

FIG. 2. Expression and kinase activity of the STAT5JAK2 fusion proteins in transiently transfected COS cells. COS-7 cells were transfected with expression plasmids encoding JAK2 (lane 2), STAT5JAK2 (lane 3), STAT5Δ750VP16JAK2 (lane 4), STAT5Δ750STAT6JAK2 (lane 5), and STAT5Δ750JAK2 (lane 6). Untransfected cells (lane 1) served as controls. Lysates were prepared and immunoprecipitated with a JAK2-specific antibody. A, the immunoprecipitates were fractionated by SDS-gel electrophoresis and analyzed by Western blotting with a JAK2-specific antibody. B, the immunoprecipitates were incubated with [γ -³²P]ATP and separated by SDS-polyacrylamide gel electrophoresis, and phosphorylated proteins were visualized by autoradiography.

toradiography (Fig. 2B). Phosphorylation of all constructs was detected, indicating that the JAK2 domain integrated into the fusion proteins is enzymatically active and can catalyze auto- or cross-phosphorylation. The expression levels and enzyme activity detected in the *in vitro* kinase assays are not strictly proportional.

Specific DNA Binding Activities of the STAT-JAK Fusion Proteins—We also investigated the DNA binding properties of the STAT-JAK fusion proteins expressed in the transfected COS cells. Whole cell extracts were prepared and were analyzed in bandshift experiments (Fig. 3A). The high affinity binding site from the β-casein gene promoter served as a probe. Only a fast migrating, nonspecific DNA protein complex was observed in untransfected COS cells (lane 1). Transfection with STAT5JAK2 (lanes 2–7) resulted in the appearance of two specific complexes (lane 2). The slower migrating one corresponds to the STAT5JAK2-DNA complex. It can be supershifted with an antibody specific for JAK2 (lane 3) or an antibody specific for STAT5 (lane 4). The second specific band observed corresponds to a complex between the DNA probe and the endogenous STAT1, activated by the transfected JAK2 fusion molecule. It can be supershifted with an antibody directed against the NH₂ terminus of STAT1 (lane 5). Cotransfection of Stat5JAK2 and Stat5 results in phosphorylation and DNA binding activity of both variants (lane 6). Both complexes

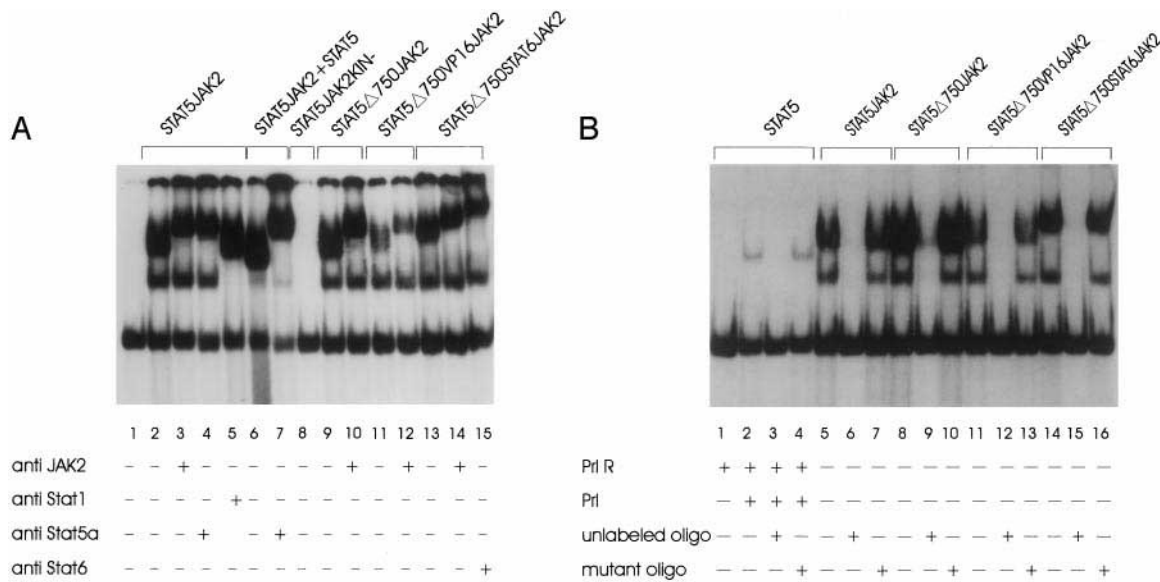

FIG. 3. Constitutive DNA binding activities of STAT5JAK2 fusion proteins. A, COS-7 cells were transfected with expression plasmids encoding STAT5JAK2 (lanes 2–7), wild type STAT5 (lanes 6 and 7), STAT5JAK2KIN⁻ (lane 8), STAT5Δ750JAK2 (lanes 9 and 10), STAT5Δ750VP16JAK2 (lanes 11 and 12), and STAT5Δ750STAT6JAK2 (lanes 13–15), or left untransfected (lane 1). Whole cell extracts were prepared, and bandshift experiments were carried out using the ³²P-labeled MGF-STAT5 binding site in the β-casein gene promoter as a probe. A JAK2-specific antiserum was included in the binding reactions shown in lanes 3, 10, 12, and 14, a STAT1-specific antiserum in the binding reaction of lane 5, a STAT5-specific antiserum in the binding reactions of lanes 4 and 7, and a STAT6-specific antiserum in the binding reaction of lane 15. B, COS-7 cells were transfected with constructs encoding STAT5 (lanes 1–4), STAT5JAK2 (lanes 5–7), STAT5Δ750JAK2 (lanes 8–10), STAT5Δ750VP16JAK2 (lanes 11–13), or STAT5Δ750STAT6JAK2 (lanes 14–16). Whole cell extracts were prepared, and bandshift experiments were performed with the same probe as in A. Unlabeled (lanes 3, 6, 9, 12, and 15) or mutant (lanes 4, 7, 10, 13, and 16) β-casein oligonucleotide in a 75-fold molar excess over the radioactive probe was included in the binding reaction.

can be supershifted by the antibody specific for Stat5 (lane 7). Specific protein-DNA complexes were also observed in extracts from cells transfected with STAT5Δ750JAK2 (lanes 9 and 10), STAT5Δ750VP16JAK2 (lanes 11 and 12), and STAT5Δ750STAT6JAK2 (lanes 13–15). These complexes can be supershifted with antiserum specific for JAK2 (lanes 10, 12, and 14) or STAT6 (lane 15). No specific complex formation was observed when the kinase-deficient fusion construct STAT5JAK2KIN⁻ (lane 8) was transfected.

When STAT5JAK2KIN⁻ was transfected together with the prolactin receptor and the cells were treated with prolactin, no DNA binding of this fusion protein was detected. Prolactin induction also did not augment the DNA binding of the constitutively activated proteins. Immunoprecipitates of the kinase-active, DNA-binding STAT5JAK variants from extracts of transfected cells reacted in Western blotting experiments with a tyrosine phosphate-specific antibody (data not shown).

The specificity of DNA binding was demonstrated in competition experiments in which non-radioactive and a mutant version of the oligonucleotide from the β-casein gene promoter were introduced into the DNA binding reactions (15) (Fig. 3B). DNA binding of STAT5, STAT5JAK2, STAT5Δ750JAK2, STAT5Δ750VP16JAK2, and STAT5Δ750STAT6JAK2 was suppressed by an excess of unlabeled β-casein promoter oligonucleotides (lanes 3, 6, 9, 12, and 15), but was not affected by addition of an oligonucleotide representing a mutant version of the STAT5 binding sequence (lanes 4, 7, 10, 13, and 16).

Transactivation Potential of the STAT-JAK Fusion Proteins in Transfected COS Cells—The transactivating potentials of the fusion proteins were evaluated (Figs. 4 and 5). For this purpose, the STAT-JAK fusion constructs were co-transfected with a β-casein gene promoter-luciferase, a cytokine-inducible SH2-containing protein (CIS) gene promoter-luciferase, or an oncostatin M (OSM) gene promoter-luciferase construct into COS-7 cells and luciferase activities were measured. These genes were previously identified as immediate early, cytokine-

responsive genes, which contain STAT5 response elements in their promoter sequences (31–33).

Wild type STAT5 can be activated in COS7 cells after co-transfection with the prolactin receptor and prolactin treatment of the cells. This results in the transcriptional induction of the β-casein gene promoter (21) and an approximately 25-fold increase in luciferase activity (Fig. 4, lanes 1 and 2). A 79-fold induction of luciferase was observed when the cells were co-transfected with the STAT5Δ750VP16JAK2 construct (lane 3). Similarly to the β-casein gene promoter construct, the CIS-luciferase and the OSM-luciferase constructs showed a modest inducibility with STAT5 activated through the prolactin receptor and a high activity upon co-expression with the STAT5Δ750VP16JAK2 construct.

Only a slightly increased luciferase activity from the β-casein gene promoter construct was observed when STAT5JAK2 was introduced into the cells (Fig. 5, lane 2) and compared with the luciferase activity obtained upon expression of latent STAT5 (lane 1). In contrast to that of STAT5 (Fig. 4, lanes 1 and 2), the activity of STAT5JAK2 could not be enhanced by co-transfection of the prolactin receptor and prolactin induction (data not shown). Predictably, STAT5JAK2KIN⁻ and STAT5Δ750JAK2 were also unable to activate transcription of the β-casein luciferase construct (Fig. 5, lane 3 and 4) in the presence or the absence of the prolactin receptor and induction with prolactin (data not shown). Replacement of the STAT5 transactivation domain with the transactivation domain of the Herpes simplex virus transactivator VP16 or of STAT6 resulted in enhanced transactivation (lanes 5 and 6). These results confirm our previous observations on the relative strengths of these transactivation domains (34).

Tetracycline-dependent Expression and Transactivation Properties of STAT5-JAK2 Fusion Proteins in Stably Transfected HeLa Cells—To corroborate the results obtained in transiently transfected COS cells, we established a second cell system, which allowed us to investigate the properties of the

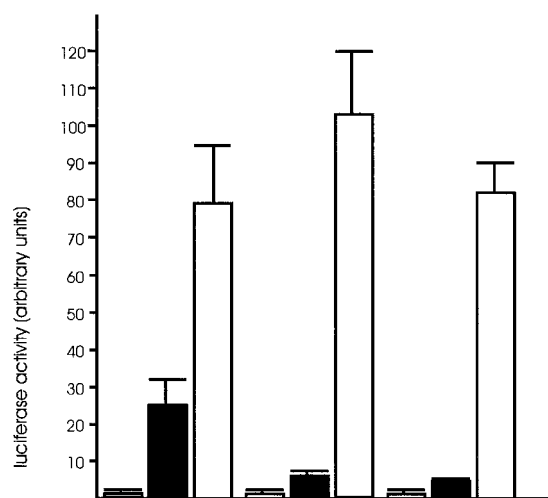

| | 1 | 2 | 3 | 4 | 5 | 6 | 7 | 8 | 9 |
|-------------------------------------|---|---|---|---|---|---|---|---|---|
| Prl-R | + | + | - | + | + | - | + | + | - |
| STAT5 α | + | + | - | + | + | - | + | + | - |
| STAT5 α Δ 750VP16JAK2 | - | - | + | - | - | + | - | - | + |
| β -casein luc | + | + | + | - | - | - | - | - | - |
| CIS luc A | - | - | - | + | + | + | - | - | - |
| OSM luc HB | - | - | - | - | - | - | + | + | + |
| Prl | - | + | - | - | + | - | - | + | - |

FIG. 4. Transcriptional activation of STAT5 target gene promoters by STAT5 α and STAT5 α Δ 750VP16JAK2 in COS cells. COS-7 cells were cotransfected with luciferase reporter constructs driven by the β -casein promoter (*lanes 1–3*), the CIS gene promoter (*CIS luc A, lanes 4–6*), or the oncostatin M promoter (*OSM luc HB, lanes 7–9*), and STAT5 α and the prolactin receptor (*lanes 1, 2, 4, 5, 7, and 8*) or STAT5 α Δ 750VP16JAK2 (*lanes 3, 6, and 9*). Cells were induced with prolactin for 15 h or left untreated. Luciferase activities were determined after 48 h. A β -galactosidase gene was always included to normalize for transfection efficiency.

STAT5-JAK2 fusion proteins. This cellular system is based on the stable introduction of the STAT5-JAK2 fusion gene constructs into HeLa cells and the conditional regulation of transgene expression by a promoter sequence sensitive to the action of tetracycline. A tTA is constitutively expressed in these cells and stimulates transcription from a minimal promoter sequence combined with tetracycline operator sequences. The transactivator is not able to bind to tetracycline operator sequences, and the promoter is silent in the presence of low concentrations of tetracycline. Induction can be achieved by tetracycline withdrawal (20).

Two cellular clones transfected with STAT5 Δ 750VP16JAK2 and two clones transfected with STAT5 Δ 750STAT6JAK2 were investigated for the expression of the fusion proteins upon tetracycline withdrawal (Fig. 6). Western blot analysis of cellular extracts and development with a JAK2-specific antiserum revealed the induction STAT5 Δ 750VP16JAK2 (*lanes 1–4*; 132 kDa) and STAT5 Δ 750STAT6JAK2 (*lanes 5–8*; 142 kDa). Band-shift experiments, with the MGF-STAT5 binding site from the rat β -casein promoter as a probe, were carried out. Specific DNA binding of both proteins was observed (data not shown), indicating that tyrosine phosphorylation and dimerization had occurred.

Ligand binding to cytokine receptors usually causes not only the activation of the JAK-STAT pathway, but also the activation of ERK/MAPK. ERK2/MAPK activation, as a consequence of *e.g.* growth hormone receptor engagement, has been shown

to be JAK2-mediated. Two mechanisms have been suggested to account for the role of JAK2. One suggests the conventional phosphorylation of tyrosine residues in the intracellular domain of the receptor, the recruitment of Ras regulating proteins, and the activation of ERK2/MAPK via Raf and MEK. Alternatively, Ras activation could occur via Sos-linked adaptor proteins, which bind directly to a phosphotyrosine residue within JAK2 (35–38). Since the STAT5-JAK2 fusion proteins contain active JAK2 kinase domains, we investigated the possibility that the MAPK pathway is activated in STAT5 Δ 750VP16JAK2-transfected HeLa cells upon tetracycline withdrawal. ERK2 activity was determined by immunoprecipitation of the enzyme from cell lysates with a specific antiserum, addition of myelin basic protein and [γ - 32 P]ATP, incubation, and gel electrophoresis. Extracts from cells stimulated with EGF served as controls. No ERK2 activities were detected in STAT5 Δ 750VP16JAK2-expressing cells (Fig. 7, *lanes 2 and 4*). ERK2 activity induced by EGF (*lanes 1 and 3*) was independent from STAT5 Δ 750VP16JAK2 expression.

The fusion proteins STAT5 Δ 750VP16JAK2 and STAT5 Δ 750STAT6JAK2 were also found to be potent transactivators in HeLa cells (Fig. 8). Two individual HeLa cell clones transfected with STAT5 Δ 750VP16JAK2 (clone 3, *lanes 1 and 2*; and clone 9, *lanes 3 and 4*) or STAT5 Δ 750STAT6JAK2 (clone 6, *lanes 5 and 6*; and clone 7, *lanes 7 and 8*) were analyzed. The cells were cultured in the presence (*lanes 1, 3, 5, and 7*) or for 48 h in the absence (*lanes 2, 4, 6, and 8*) of tetracycline and subsequently transfected with a β -casein promoter-luciferase gene construct. After 48 h, luciferase activities were determined. Inductions (30–50-fold) of luciferase activity were observed in all four cell clones. Equivalent experiments were carried out with stably transfected human breast carcinoma cells, SK-BR3. Induction of STAT5 Δ 750VP16JAK2 or STAT5 Δ 750STAT6JAK2 by tetracycline withdrawal caused a 50–60-fold induction of a β -casein promoter-luciferase reporter construct (data not shown).

DISCUSSION

Our experiments show that the fusion of the kinase domain of JAK2 to the carboxyl terminus of STAT5 results in a chimeric protein that is constitutively activated and able to bind to the STAT5 response element independently of cytokine receptor activation. The fusion proteins are tyrosine-phosphorylated. This phosphorylation can be the result of an intra- or an intermolecular reaction. The activation of the endogenous STAT1 molecules or co-transfected wild type STAT5 molecules indicates that intermolecular phosphorylation events take place. Interestingly, the STAT1 phosphorylation is dependent upon the JAK2 kinase activity present in the STAT5JAK2 fusion molecule. Transfected wild type JAK2 is not able to phosphorylate and activate STAT1, endogenous to COS7 cells.

DNA binding of the STAT5JAK2 fusion molecules is not sufficient in all cases for transcriptional activation. STAT5JAK2 and STAT5 Δ 750JAK2 show strong DNA binding, but do not transactivate. This is not surprising for STAT5 Δ 750JAK2, since this molecule lacks the endogenous STAT5 TAD. The lack of transactivation potential of STAT5JAK2 might be due to the particular properties of the TAD of STAT5. We have previously observed that this TAD is very weak when linked to a GAL4 DNA binding domain. It only affects a 3-fold induction (9). For full transcriptional induction, STAT5 requires the interaction with coactivators. The simultaneous activation of the glucocorticoid receptor and the complex formation with STAT5 strongly enhances transcription (39). It is possible that the fusion of the JAK2 kinase domain to the carboxyl terminus of STAT5 might interfere with this interaction. The increasing strength in transactivation function

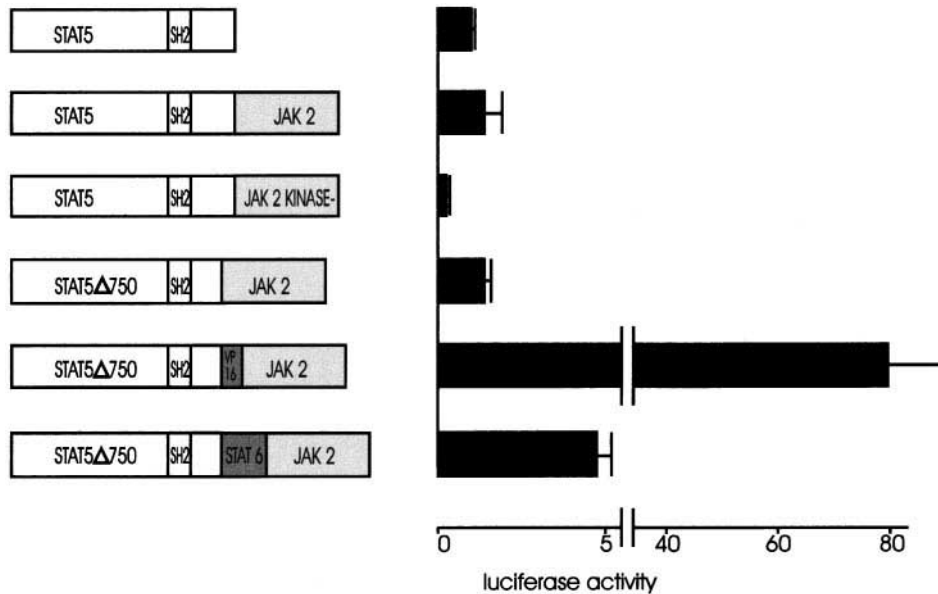

FIG. 5. Cytokine-independent transcriptional activation of a β -casein promoter-luciferase reporter gene construct by the STAT5JAK2 fusion proteins in COS cells. COS-7 cells were co-transfected with constructs encoding a β -casein promoter-luciferase construct and wild type STAT5 (line 1), STAT5JAK2 (line 2), STAT5JAK2KIN- (line 3), STAT5 Δ 750JAK2 (line 4), STAT5 Δ 750VP16JAK2 (line 5), and STAT5 Δ 750STAT6JAK2 (line 6). Luciferase activities were determined after 48 h. A β -galactosidase expression vector was included in the transfections to correct for transfection efficiencies.

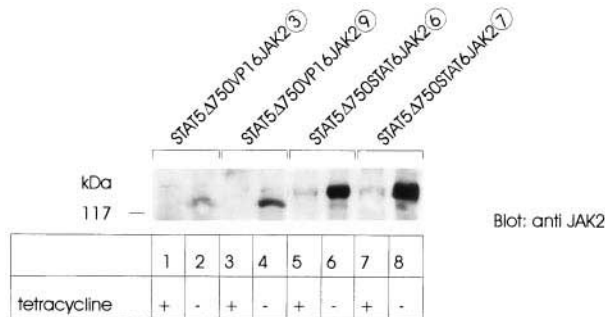

FIG. 6. Tetracycline-regulated expression of STAT5 Δ 750VP16JAK2 and STAT5 Δ 750STAT6JAK2 in stably transfected HeLa cells. HeLa cells stably expressing the transactivator tTA1 were transfected with the plasmids pBSpac Δ p encoding a puromycin resistance gene and p10/3 STAT5 Δ 750VP16JAK2 or p10/3 STAT5 Δ 750STAT6JAK2. Cells were cultured in the presence of tetracycline (1 μ g/ml) and puromycin (1.25 μ g/ml), and cell clones were obtained. The expression of the fusion proteins was induced by the withdrawal from tetracycline for 48 h. Cell extracts were prepared from cell clones transfected with the STAT5 Δ 750VP16JAK2 construct (lanes 1-4) or the STAT5 Δ 750STAT6JAK2 construct (lanes 5-8). Upon SDS-gel electrophoresis, the fusion proteins were visualized by Western blotting with a JAK2-specific antiserum.

of the STAT5, STAT6, and VP16 TADs might be attributable to the recruitment of different co-activators. The observation that three STAT5 target genes can be induced by the STAT5-JAK2 constructs provided with different TADs suggests that the qualitative regulation exerted by the specific DNA binding domain might be augmented by a quantitative regulation based on the interaction between the TADs and specific co-activators. Alternatively, it is possible that the transactivation function of STAT5 is regulated independently from its DNA binding function and that additional phosphorylation events are required (40, 41). This type of regulation is not observed when heterologous TADs are incorporated into the STAT5JAK2 fusions. The inclusion of the strong TADs of VP16 or the moderately active TADs of STAT6 results in the induction of transcription of a β -casein luciferase construct.

We have also quantitated the expression of a reporter gene

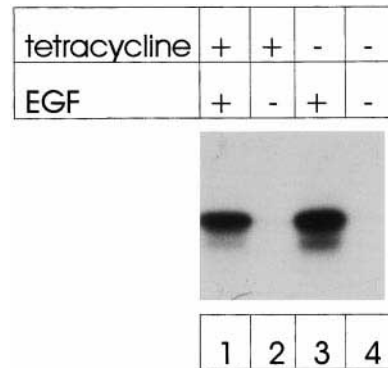
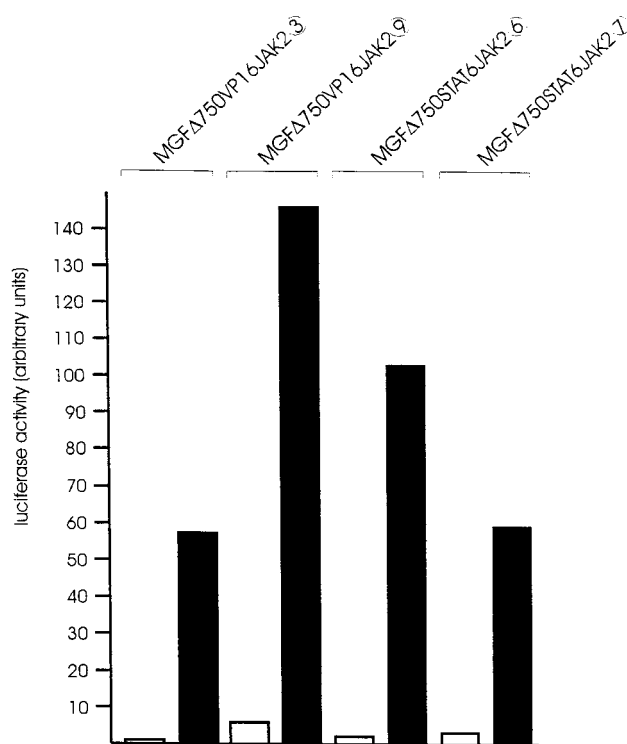

FIG. 7. MAP kinase activity in HeLa cells expressing the STAT5 Δ 750VP16JAK2 fusion protein. STAT5 Δ 750VP16JAK2-transfected HeLa cells were withdrawn from tetracycline for 48 h, lysed in ERK lysis buffer (50 mM β -sodium-glycerophosphate, 1.5 mM EGTA pH 8.5, 2 mM Na_3VO_4 , 1 mM dithiothreitol, 2 μ g/ml leupeptin, 2 μ g/ml aprotinin, 1 mM benzamide, 1% Nonidet P-40). ERK2 activity was determined by immunoprecipitation of the enzyme from cell lysates with a specific antiserum (Santa Cruz), dissolution in kinase buffer (30 mM Tris, pH 8.0, 20 mM MgCl_2 , 2 mM MnCl_2), addition of myelin basic protein (15 μ g) and 10 μ M ATP, 0.1 μ Ci of [32 P]ATP, incubation for 30 min at 37 $^\circ$ C, gel electrophoresis, and autoradiography. Extracts from cells stimulated with EGF served as controls. No ERK2 activities were detected in STAT5 Δ 750VP16JAK2-expressing cells (lanes 2 and 4). ERK2 activity induced by EGF (lanes 1 and 3) was independent from STAT5 Δ 750VP16JAK2 expression.

construct that is regulated by the cytomegalovirus promoter, *i.e.* does not contain a STAT5 binding site, in cells expressing the STAT5-JAK2 fusion proteins. We observed that the expression of this gene is not affected by the STAT5-JAK2 fusion proteins. The activation of the fusion constructs is not limited to transiently transfected COS cells, but can also be observed in stably transfected HeLa cells or SK-BR3 cells upon induction of the genes through a conditional promoter. In these cells, the expression of the constitutively active JAK2 tyrosine kinase domain present in the fusion proteins does not enhance MAPK activity. This observation strengthens our premise that the chimeric proteins will be potent tools to study the effects of STAT5 independent from receptor stimulation and activation



| | 1 | 2 | 3 | 4 | 5 | 6 | 7 | 8 |
|--------------|---|---|---|---|---|---|---|---|
| β-casein luc | + | + | + | + | + | + | + | + |
| tetracycline | + | - | + | - | + | - | + | - |

FIG. 8. Transcriptional activation of a β -casein luciferase reporter gene in HeLa cells induced by tetracycline withdrawal to express STAT5 Δ 750VP16JAK2 and STAT5 Δ 750STAT6JAK2. Two individual clones of HeLa cells transfected with the STAT5 Δ 750VP16JAK2 (clone 3, lanes 1 and 2; and clone 9, lanes 3 and 4) or STAT5 Δ 750STAT6JAK2 (clone 6, lanes 5 and 6; and clone 7, lanes 7 and 8) were cultured in the presence (lanes 1, 3, 5, and 7) or for 48 h in the absence (lanes 2, 4, 6, and 8) of tetracycline. The cells were transfected with a β -casein luciferase reporter gene construct and a β -galactosidase gene. After 48 h, luciferase and β -galactosidase activities were determined. β -Galactosidase activities served to normalize for transfection efficiencies.

of other signaling pathways. They will also facilitate the identification of new target genes of STAT proteins.

Acknowledgments—We thank Roland Schüle and Erich Greiner (Institute for Experimental Cancer Research, Freiburg, Germany) and Thomas Stamminger (Institute of Virology, University of Erlangen, Erlangen, Germany) for plasmids, Atsushi Miyajima (Institute of Molecular and Cellular Biology, Tokyo University, Tokyo, Japan) for the CIS luc A and OSM luc HB reporter constructs, Markus Heim (University Hospital Basel, Basel, Switzerland) for the Stat6-specific antiserum, Christian Beisenherz (Institute for Experimental Cancer Research, Freiburg, Germany) for helpful discussions, Nancy Hynes (Friedrich Miescher Institute Basel, Basel, Switzerland) for reviewing the manuscript, and Ines Fernandez for editorial assistance.

REFERENCES

- Kazlauskas, A. (1994) *Curr. Opin. Genet. Dev.* **4**, 5–14
- Taniguchi, T. (1995) *Science* **268**, 251–255
- Boonstra, J., Rijkken, P., Humbel, B., Cremers, F., Verkleij, A., and Van Bergen en Henegouwen, P. (1995) *Cell Biol. Int.* **19**, 413–430
- Minami, Y., Oishi, I., Liu, Z. J., Nakagawa, S., Miyazaki, T., and Taniguchi, T. (1994) *J. Immunol.* **152**, 5680–5690
- Bennett, A. M., Hausdorff, S. F., O'Reilly, A. M., Freeman, R. M., and Neel, B. G. (1996) *Mol. Cell. Biol.* **16**, 1189–1202
- Heim, M. H. (1996) *Eur. J. Clin. Invest.* **26**, 1–12
- Thierfelder, W. E., van Deursen, J. M., Yamamoto, K., Tripp, R. A., Sarawar, S. R., Carson, R. T., Sangster, M. Y., Vignali, D. A. A., Doherty, P. C., Grosfeld, G. C., and Ihle, J. N. (1996) *Nature* **382**, 171–174
- Gobert, S., Chretien, S., Gouilleux, F., Muller, O., Pallard, C., Dusanter-Fourt, I., Groner, B., Lacombe, C., Gisselbrecht, S., and Mayeux, P. (1996) *EMBO J.* **15**, 2434–2441
- Moriggl, R., Gouilleux-Gruart, V., Jähne, R., Berchtold, S., Gartmann, C., Liu, X., Hennighausen, L., Sotiropoulos, A., Groner, B., and Gouilleux, F. (1996) *Mol. Cell. Biol.* **16**, 5691–5700
- Groner, B., and Gouilleux, F. (1995) *Curr. Opin. Genet. Dev.* **5**, 587–594
- Schmitt-Ney, M., Doppler, W., Ball, R. K., and Groner, B. (1991) *Mol. Cell. Biol.* **11**, 3745–3755
- Wakao, H., Gouilleux, F., and Groner, B. (1994) *EMBO J.* **13**, 2182–2191
- Azam, M., Erdjument-Bromage, H., Kreider, B. L., Xia, M., Quelle, F., Basu, R., Saris, C., Tempst, P., Ihle, J. N., and Schindler, C. (1995) *EMBO J.* **14**, 1402–1411
- Gouilleux, F., Moritz, D., Humar, M., Moriggl, R., Berchtold, S., and Groner, B. (1995) *Endocrinology* **136**, 5700–5708
- Gouilleux, F., Pallard, C., Dusanter-Fourt, I., Wakao, H., Haldosen, L.-A., Norstedt, G., Levy, D., and Groner, B. (1995) *EMBO J.* **14**, 2005–2013
- Mui, A. L.-F., Wakao, H., O'Farrell, A.-M., Harada, N., and Miyajima, A. (1995) *EMBO J.* **14**, 1166–1175
- Pallard, C., Gouilleux, F., Bénil, L., Cocault, L., Souyri, M., Levy, D., Groner, B., Gisselbrecht, S., and Dusanter-Fourt, I. (1995) *EMBO J.* **14**, 2847–2856
- Ruff-Jamison, S., Chen, K., and Cohen, S. (1995) *Proc. Natl. Acad. Sci. U. S. A.* **92**, 4215–4218
- Mui, A. L.-F., Wakao, H., Kinoshita, T., Kitamura, T., and Miyajima, A. (1996) *EMBO J.* **15**, 2425–2433
- Gossen, M., and Bujard, H. (1992) *Proc. Natl. Acad. Sci. U. S. A.* **89**, 5547–5551
- Gouilleux, F., Wakao, H., Mundt, M., and Groner, B. (1994) *EMBO J.* **13**, 4361–4369
- Wakao, H., Schmitt-Ney, M., and Groner, B. (1992) *J. Biol. Chem.* **267**, 16365–16370
- Darnell, J. E., Jr., Kerr, I. M., and Stark, G. M. (1994) *Science* **264**, 1415–1421
- Ihle, J. N. (1995) *Nature* **377**, 591–594
- Ihle, J. N. (1996) *Cell* **84**, 331–334
- Silvennoinen, O., Witthuhn, B. A., Quelle, F. A., Cleveland, J. L., Yi, T., and Ihle, J. N. (1993) *Proc. Natl. Acad. Sci. U. S. A.* **90**, 8429–8433
- Ihle, J. N., Witthuhn, B. A., Quelle, F. W., Yamamoto, K., Thierfelder, W. E., Kreider, B., and Silvennoinen, O. (1994) *Trends Biochem. Sci.* **19**, 222–227
- Frank, S. J., Yi, W., Zhao, Y., Goldsmith, J. F., Gilliland, G., Jiang, J., Sakai, I., and Kraft, A. S. (1995) *J. Biol. Chem.* **270**, 14776–14785
- Nakamura, N., Chin, H., Miyasaka, N., and Miura, O. (1996) *J. Biol. Chem.* **271**, 19483–19488
- Liu, X., Robinson, G. W., Gouilleux, F., Groner, B., and Hennighausen, L. (1995) *Proc. Natl. Acad. Sci. U. S. A.* **92**, 8831–8835
- Yoshimura, Y., Ohkubo, T., Kiguchi, T., Jenkins, N. A., Gilbert, D. J., Copeland, N. G., Hara, T., and Miyajima, A. (1995) *EMBO J.* **14**, 2816–2826
- Yoshimura, Y., Ichihara, M., Kinjyo, I., Moriyama, M., Copeland, N. G., Gilbert, D. J., Jenkins, N. A., Hara, T., and Miyajima, A. (1996) *EMBO J.* **15**, 1055–1063
- Matsumoto, A., Masuhara, M., Mitsui, K., Yokouchi, M., Ohtsubo, M., Misawa, H., Miyajima, A., and Yoshimura, A. (1997) *Blood* **89**, 3148–3154
- Moriggl, R., Berchtold, S., Friedrich, K., Standke, G. J. R., Kammer, W., Heim, M., Wissler, M., Stöcklin, E., Gouilleux, F., and Groner, B. (1997) *Mol. Cell. Biol.* **17**, 3663–3678
- Winston, L. A., and Hunter, T. (1995) *J. Biol. Chem.* **270**, 30837–30840
- Winston, L. A., and Hunter, T. (1996) *Curr. Biol.* **6**, 668–671
- Han, Y., Leaman, D. W., Watling, D., Rogers, N. C., Groner, B., Kerr, I. M., Wood, W. I., and Stark, G. R. (1996) *J. Biol. Chem.* **271**, 5947–5952
- Xia, K., Mukhopadhyay, N. K., Inhorn, R. C., Barber, D. L., Rose, P. E., Lee, R. S., Narsimhan, R. P., D'Andrea, A. D., Griffin, J. D., and Roberts, T. M. (1996) *Proc. Natl. Acad. Sci. U. S. A.* **93**, 11681–11686
- Stöcklin, E., Wissler, M., Gouilleux, F., and Groner, B. (1996) *Nature* **383**, 726–728
- Wen, Z., Zhong, Z., and Darnell, J. E., Jr. (1995) *Cell* **82**, 241–250
- Zhang, X., Blenis, J., Li, H.-C., Schindler, C., and Chen-Kiang, S. (1995) *Science* **267**, 1990–1994