



HAL
open science

Influence of topology and diode characteristics of AC-DC converters for low power piezoelectric energy harvesting

Kevin Nadaud, Guylaine Poulin-Vittrant, Daniel Alquier

► **To cite this version:**

Kevin Nadaud, Guylaine Poulin-Vittrant, Daniel Alquier. Influence of topology and diode characteristics of AC-DC converters for low power piezoelectric energy harvesting. *Sensors and Actuators A: Physical*, 2021, pp.112901. <10.1016/j.sna.2021.112901>. <hal-03254666>

HAL Id: hal-03254666

<https://univ-tours.hal.science/hal-03254666v1>

Submitted on 9 Jun 2021

HAL is a multi-disciplinary open access archive for the deposit and dissemination of scientific research documents, whether they are published or not. The documents may come from teaching and research institutions in France or abroad, or from public or private research centers.

L'archive ouverte pluridisciplinaire **HAL**, est destinée au dépôt et à la diffusion de documents scientifiques de niveau recherche, publiés ou non, émanant des établissements d'enseignement et de recherche français ou étrangers, des laboratoires publics ou privés.



HAL Authorization

Influence of topology and diode characteristics of AC-DC converters for low power piezoelectric energy harvesting

Kevin Nadaud*, Guylaine Poulin-Vittrant[†], and Daniel Alquier[‡]

GREMAN UMR 7347, Université de Tours, CNRS, INSA-CVL, 16 rue Pierre et Marie Curie, 37071 Tours, France

June 1, 2021

Abstract

Most often, piezoelectric generators are connected to a AC-DC converter, also called rectifier, to obtain a continuous energy which can be regulated and stored. In the case of low power generators, the choice of the rectifier is critical since the losses into this circuit are not negligible and should be as low as possible.

In this paper, different topologies of rectifier using different diode references are studied to rectify the output voltage of a piezoelectric generator. We show that the differences between the fullwave rectifier and a voltage doubler are quite small in terms of output power. The main differences are visible on the final voltage value and the optimal load. On the contrary, the choice of diodes is critical, especially the reverse leakage current which must be limited since it largely affects the output power for low power generators.

The internal capacitance of the generator also plays an important role since it changes the capability of the generator to provide current. We show that low threshold voltage diodes are more appropriate for generators presenting a high internal capacitance while low leakage current are preferable for generators presenting a low internal capacitance value.

Keywords: energy harvesting, piezoelectric, modeling, rectifier

1 Introduction

To supply the ever-increasing number of portable devices, a tendency is to build generators, in particular piezoelectric ones (PG) to harvest the wasted mechanical energy which can have various origins (ambient vibrations, human body movements, etc.). In order to directly implement the lead-free directives, developments of nanomaterials such as ZnO nanowires have been investigated in PGs due to their piezoelectric properties and bio-compatibility¹⁻⁵. PGs can be used to provide the electrical energy to devices such as sensors, actuators and wireless transmitters⁶⁻⁹. A temporary energy storage element may be needed, like a capacitor^{10,11} or a small embedded battery^{12,13}. In both cases, the PG must be connected to the storage element through

*Email: kevin.nadaud@univ-tours.fr ORCID: 0000-0002-2969-1453

[†]Email: guylaine.poulin-vittrant@univ-tours.fr ORCID: 0000-0003-0501-8122

[‡]Email: daniel.alquier@univ-tours.fr ORCID: 0000-0003-1345-8195

33 an AC-DC converter, also called rectifier, since the electrical output of the PG is alternative. The
 34 architecture of the rectifier is closely related to both the PG and the storage element. Various
 35 topologies have been proposed, from simple 4-diodes bridges¹⁴, voltage multipliers¹⁰ or more
 36 complex circuits using synchronized switch technique^{15,16}.

37 Even if some bridge-less topologies have been reported^{17,18}, they require an external con-
 38 troller for the switches whose consumption is not always taken into account for the efficiency
 39 calculation. A truly autonomous device must include a passive rectifier to provide the energy
 40 consumed by the control circuit of the active AC-DC converter.

41 In this paper, we focus mainly on passive rectifiers since they do not require energy to control
 42 electronic switches. Even if they present intrinsic losses due to diodes or passive components,
 43 passive rectifiers are appropriate when the total power supplied by the harvester is small, for
 44 example piezoelectric nanowires based device^{1-5,19}

45 The goal of this paper is to study different topologies of AC-DC converter in order to find
 46 out the most suitable for low power energy harvesting. Moreover, the effect of the diode char-
 47 acteristics, forward voltage V_f and reverse current I_r , is also studied. For this purpose, different
 48 references of diode have been selected with various values of forward voltage and reverse cur-
 49 rent. The goal is here to know for a given energy source, which parameter is critical and which
 50 rectifier topology is suitable.

51 2 Materials and methods

52 2.1 Rectifiers and diodes

53 In this section, the two studied rectifier topologies and the characteristics of the chosen diodes
 54 are presented. The first rectifier is the well known fullwave rectifier based on 4 diodes as shown
 55 Fig. 1a. For this circuit, both polarities are rectified which increases the total amount of energy
 56 transmitted to the load compared to a single diode rectifier. The main drawback of this circuit is
 57 the diode voltage drop, since the threshold of the diodes is present twice. The consequence is a
 58 lower magnitude of the expected final voltage when the capacitor is fully charged compared to
 59 the initial alternative voltage, and also to the voltage, that would be obtained thanks to a single
 60 diode rectifier.

61 The second rectifier is the Latour voltage doubler as presented Fig. 1b. The advantage of this
 62 circuit is a lower voltage drop across the diode, which is present only one time for each polarity.
 63 In open circuit condition (resistive load R_L infinite), the voltage at the output of the circuit is
 64 close to twice the voltage magnitude at the input of the rectifier, and it is only diminished by the
 65 forward voltage drop of the diode. Similarly to the fullwave bridge, both polarities of the signal
 66 are rectified contrary to the simple rectifier. C_0 capacitors are just here to provide a mid-point

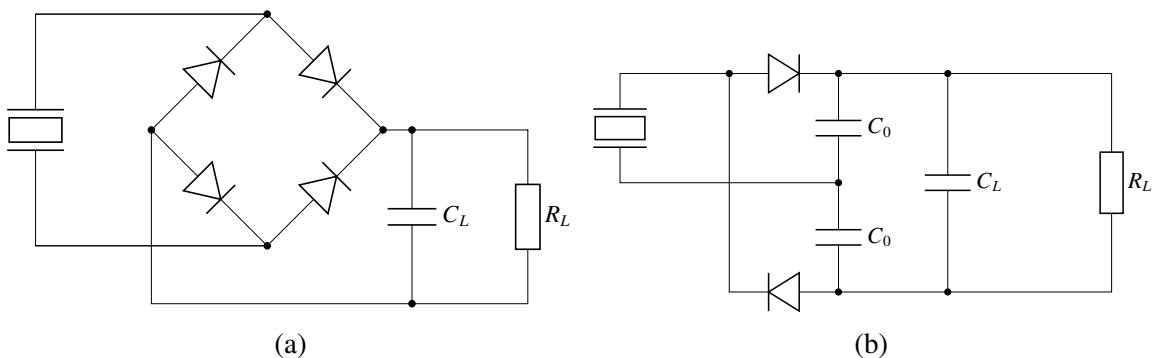

Figure 1: Studied rectifier, full wave bridge rectifier (a) and Latour voltage doubler circuit (b).

Table 1: Summary of the available diodes, ordered by increasing threshold voltage. Given values are typical from the datasheet at 25 °C.

		Reference			
Condition		1PS76SB10	1PS79SB30	RB751S40	1N4148
V_f	$I_f = 100 \mu\text{A}$	150 mV	190 mV	260 mV	500 mV
	$I_f = 10 \text{ mA}$	300 mV	310 mV	390 mV	750 mV
I_r	$V_r = 5 \text{ V}$	500 nA	130 nA	13 nA	5 nA
	$V_r = 20 \text{ V}$	1000 nA	280 nA	40 nA	12 nA

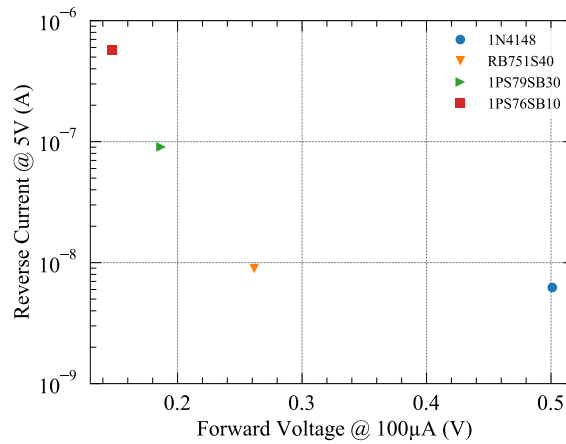

Figure 2: Reverse leakage current at 5 V as a function of the forward threshold voltage at 100 μA for the studied diodes.

67 to connect the second terminal of the generator, their values are small compared to the storage
68 capacitor C_L .

69 The value of the storage capacitor has been chosen to have a usable voltage at the output of
70 the AD-DC converter, i.e. a small voltage ripple in order to avoid the use of a voltage regulator.
71 We choose a ceramic capacitor with a value of 1 μF , while and a larger value may be used if a
72 lower ripple or higher stored energy are needed.

73 The aim of this part is to present the diode types that were chosen in this study. When
74 choosing a diode there is a trade-off between (i) a low forward voltage when the diode is on,
75 also called the threshold voltage, and (ii) a low reverse current when the diode is off, also called
76 leakage current. These two parameters are linked together and decreasing the threshold voltage
77 has the consequence to increase the leakage current. The selected diodes are three Schottky
78 barrier diodes (1PS76SB10, 1PS79SB30 and RB751S40) and one $p-n$ junction diode (1N4148).
79 Table 1 summarizes the forward voltage and leakage current for the different diodes and Fig. 2
80 shows the reverse leakage current at -5 V as a function of the forward threshold voltage at
81 100 μA for the studied diodes.

82 Since the selected references are commonly used, the SPICE model of the diodes, given in
83 supplementary material, can be easily found and have been downloaded from²⁰. Fig. 3 shows
84 the simulation results and the forward and reverse current as a function of the forward and
85 reverse voltage for the different diodes at room temperature. For all diode references, there is a
86 good agreement between datasheet results and simulations indicating that the electrical model
87 describes correctly the diode behavior in forward and reverse conditions.

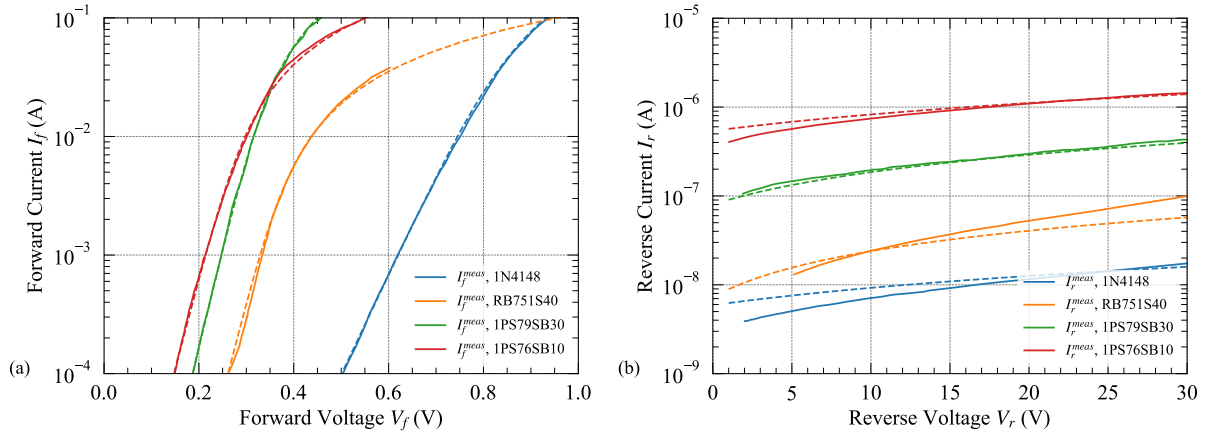

Figure 3: Forward (a) and reverse (b) currents as a function of the forward and reverse voltage respectively for different diodes at 25 °C. Full lines correspond to the datasheet values and dashed lines to the SPICE Model.

2.2 Simulation and experimental procedures

The study of the rectifiers has been made by both simulation and measurement. The electrical circuit simulations presented in this paper have been made using Xyce Electronic Simulator^{TM21}, in the time domain. The PG has been modeled by a Thevenin equivalent generator, i.e. voltage source connected in series with an internal impedance.

The experimental test bench used to characterize the rectifier is shown Fig. 4. It consists of a 6517B Keithley electrometer, used in voltage mode, a variable resistive load and a capacitor. The excitation of the PG is applied using a mechanical shaker (LDS V406) driven by a power amplifier (LDS PA100E). A function generator (Tektronix AFG1022) is used to control the magnitude and frequency of the shaker. The considered piezoelectric generator is a PZT buzzer and its internal impedance has been measured using a custom impedancemeter as presented in ref.²². The force applied onto the PG has a magnitude of 3 N and a frequency of 5 Hz. A pre-stress has been adjusted to keep the contact during the full period of the mechanical excitation. An oscilloscope (MDO3014 Tektronix) is used to monitor the voltage at the output of the PG, the function generator output and the force magnitude. The applied force is monitored using a force sensor and the magnitudes of both the force and prestress are recorded in order to ensure that all the tests are performed in the same conditions. Electrical isolation between the sample and the mechanical structure of the test bench is made using glass slides.

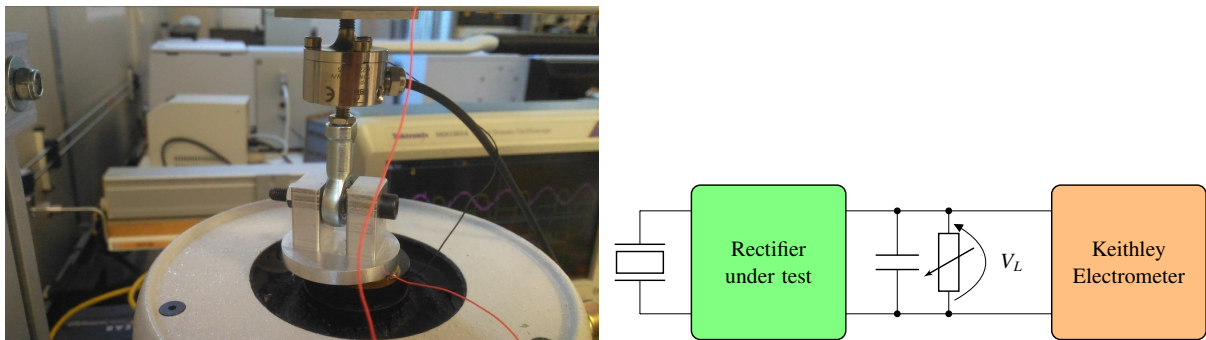

Figure 4: Description of the used test bench to characterize a rectifier.

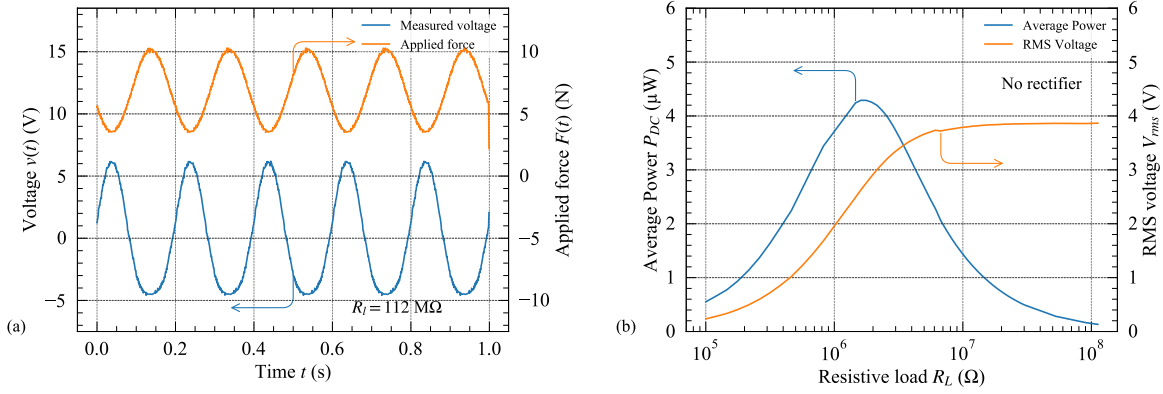

Figure 5: Applied force onto the PG as a function of time and voltage measured with a resistive load of $113 \text{ M}\Omega$ (a). RMS voltage and average power as a function of the resistive load for the same PG connected directly to a resistive load (b).

3 Results and discussion

In this experimental part, the PG is firstly characterized only with a resistive load in order to measure the voltage signal response and to identify the optimal load. In a second step, the PG is connected to a resistive load through different rectifier topologies and using different diode references. In this part, average voltage, DC power dissipated in the load and rising time starting from the discharged state to reach the steady state are studied in order to know the most suitable topology/diode couple.

3.1 Without rectifier

First, the PG has been characterized without rectifier. A simple resistive load, noted R_L , has been connected in order to identify the optimal load and the harvested power at this load. Fig. 5a shows the temporal waveforms of the applied force onto the PG and corresponding measured voltage across a resistive load of $113 \text{ M}\Omega$. Even if the force is sinusoidal, the measured voltage is not perfectly sinusoidal which is attributed to the non-linear behavior of the PZT based PG, as the PG is under high level of strain. Using this temporal waveform, the RMS voltage can be computed for the given load and by changing the load, it is possible to obtain the RMS voltage and average power as a function of the resistive load.

Fig. 5b shows the RMS voltage and the average power as a function of the resistive load. The RMS voltage increases when the resistive load increases which is the expected behavior. The average power versus resistive load presents a maximum for a given resistance, called optimal load R_L^{ave} . This corresponds to the best compromise between two situations: (i) a high voltage for high value of resistance load but a small value of the current and (ii) a high current for small load value but a small voltage. In harmonic regime, the optimal load correspond to the modulus of the internal impedance and, in the case of a capacitive internal impedance, its value is known as :

$$R_L^{ave} = \frac{1}{C_{int}\omega_0} \quad (1)$$

where C_{int} is the internal capacitance of the PG and ω_0 is the angular frequency of the solicitation. With an internal impedance of 17.5 nF , the expected value of optimal load in our case is $1.82 \text{ M}\Omega$, which very close to the measured value, $1.72 \text{ M}\Omega$. The slight shift may be attributed to the presence of harmonics included in the open circuit voltage²². The power at optimal load

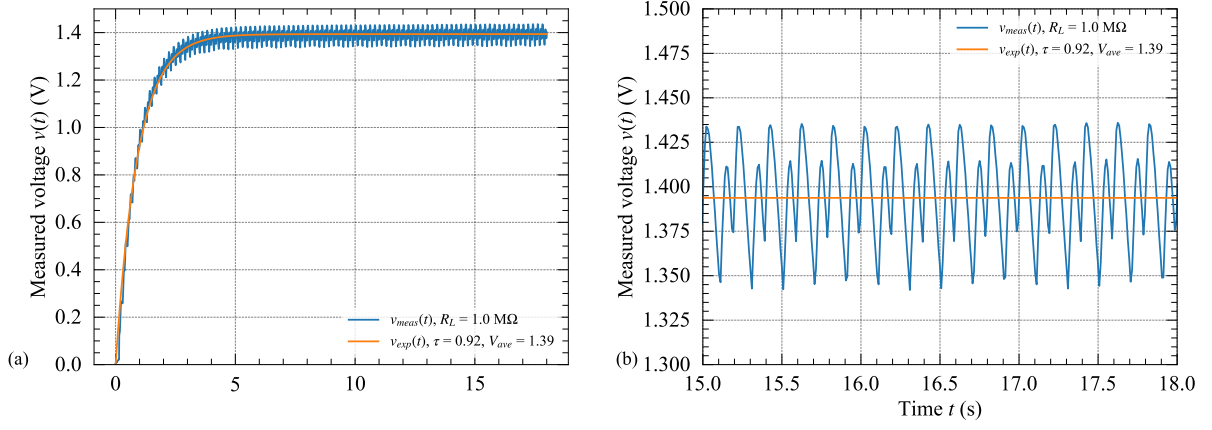

Figure 6: Typical charging curve of a capacitor of $1 \mu\text{F}$ using the fullwave rectifier using RB751S40 diodes.

134 can be computed using the following expression:

$$P_{AC}^{max} = \frac{V_{OC}^2 C_{int} \omega_0}{4} \quad (2)$$

135 The measured value ($4.29 \mu\text{W}$) is closed to the theoretical value ($4.08 \mu\text{W}$).

136 3.2 Influence of rectifier topology and diodes

137 In this second section, the influence of both the rectifier topology and diode choice on the aver-
 138 age power versus resistive load is presented. First, the average final voltage versus resistive load
 139 is presented since it corresponds to the steady state operation of the rectifier. Then, the effect
 140 of the topology and diode reference on the average power transmitted to the load is discussed.
 141 Finally, the effect of both the load and the rectifier topology, on the rising time starting from the
 142 discharged state to reach the steady state, is shown.

143 A typical measured charging curve is shown Fig. 6 which consists of the voltage across the
 144 capacitor and load as a function of the time. The voltage ripple corresponds to each half-wave
 145 which charges the storage capacitor. The low frequency component, similar to an exponential
 146 waveform, corresponds to the accumulation of energy into the capacitor. To measure the final
 147 voltage, only the steady state part is used from 10 s to 17 s in Fig. 6a. The average final voltage
 148 has been calculated using the following formula:

$$V_{ave} = \frac{1}{t_2 - t_1} \int_{t_1}^{t_2} v(t) dt \quad (3)$$

149 In order to estimate the charging time of the capacitor, the curve has been fitted using the
 150 following function:

$$v_{exp}(t) = V_{ave} \left(1 - \exp\left(\frac{-t}{\tau}\right) \right) \quad (4)$$

151 τ corresponds to the rising time and V_{ave} to the mean value of the voltage when time tends to
 152 the infinity. The τ value is a simple indicator of the charging time necessary to reach a given
 153 percentage of the final value (i.e. 3τ for 95 %, 5τ for 99 %...). Thus the fitting of the curve
 154 provides metric in order to compare results obtained with different experimental conditions and
 155 different rectifiers. In this study, we only consider a purely resistive load in addition to the

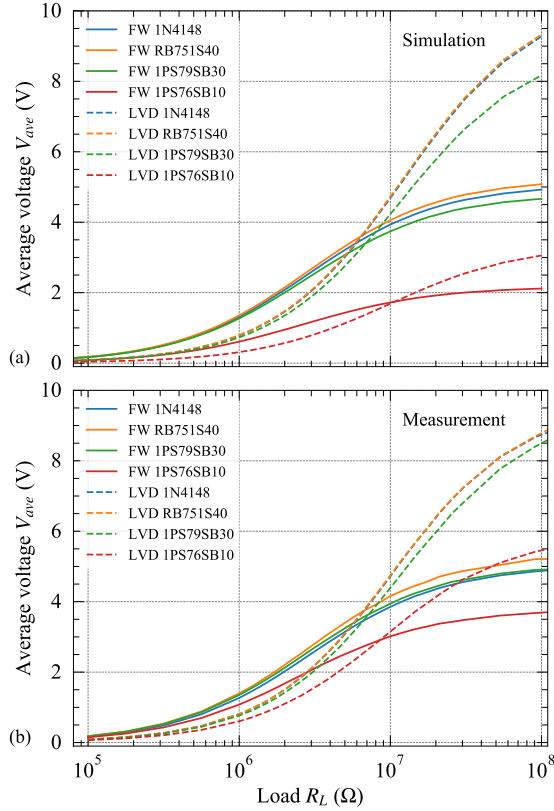

Figure 7: Final voltage as function of the resistive load for different rectifier topology and for two diode reference (a) in simulation (b) in measurement. FW stands for fullwave rectifier and LVD stands for Latour voltage doubler.

156 filtering capacitor. In the case of a real circuit, a DC-DC converter can be used in order regulate
 157 the voltage¹⁴.

158 Fig. 7 presents the simulated and measured average voltage as a function of the resistive
 159 load value for different topologies of rectifier and references of diode. For all references of
 160 diode, the voltage at high load values is higher for voltage doubler than for the fullwave bridge,
 161 a factor 2 is visible which corresponds to the expectation. This means that the fullwave rectifier
 162 is more adapted to “low” load values than the voltage doubler.

163 Concerning the effect of the diode reference, similar results are visible on both topologies:
 164 the diode with the higher leakage current (and having the lower threshold voltage) provides
 165 a lower voltage. This is counter-intuitive because, in the case of the piecewise linear model,
 166 using a diode with a lower threshold voltage, the final voltage should be higher. Nevertheless,
 167 the reverse leakage current discharges the capacitor and thus may reduce the average voltage
 168 even in the established regime (i.e. when the capacitor is almost fully charged)²³. In the other
 169 hand, even below the threshold voltage, a small current can flow through the diodes, and charges
 170 the storage capacitor, since the diode presents an exponential characteristic (and not a piecewise
 171 model). Thus the maximum voltage can be higher than the the source maximum voltage reduced
 172 by the threshold voltage. This signifies the leakage current is more critical for final voltage than
 173 the threshold voltage for the tested PG. The difference between the low leakage Schottky diode
 174 and the $p - n$ junction diode is small.

175 One can note the simulated maximum voltage for high leakage diode (1PS76SB10) is sig-
 176 nificantly lower than the voltage obtained with the other diodes. This is attributed to the really
 177 high leakage current of this diode (Table 1). Concerning the agreement between simulation and
 178 experiment, the shape of the curve and the values are close to each other for low leakage diodes,

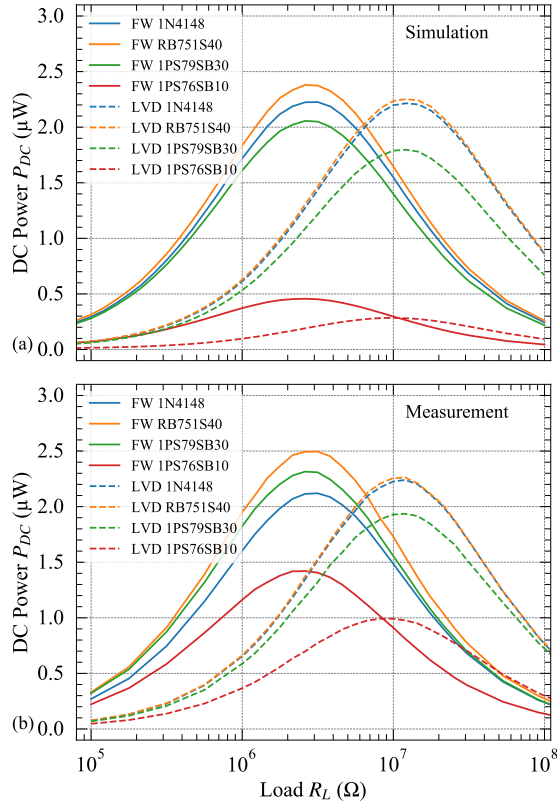

Figure 8: Power of the DC component as a function of the resistive load for different rectifier topologies and for two diode reference (a) in simulation (b) in measurement. FW stands for fullwave rectifier, full lines, and LVD stands for Latour voltage doubler, dashed lines.

179 indicating the simulation can predict accurately the output voltage. A discrepancy is visible for
 180 the high leakage diode (1PS76SB10), where in that case the simulated maximum voltage is two
 181 times lower than the measured one. This may be due to a real characteristic which is not as
 182 leaky as predicted by the datasheet.

183 Like a PG connected directly to the load without rectifying circuit, the average power de-
 184 pends on the resistive load connected to the capacitor. The goal is then to maximize the power
 185 transferred to the load, that means to maximize the dissipated power. They are two possibili-
 186 ties to compute the power, depending on which power we consider. The average power can be
 187 calculated using the following formula:

$$P_{ave} = \frac{1}{t_2 - t_1} \int_{t_1}^{t_2} \frac{(v(t))^2}{R_L} dt \quad (5)$$

188 Nevertheless, this definition considers the power contribution of all frequency components. In
 189 the case of a rectifier, it is more relevant to consider the power of only the DC-component,
 190 calculated using the formula:

$$P_{DC} = \frac{V_{ave}^2}{R_L} \quad (6)$$

191 Both average and DC powers are supposed to be equal when the rectifier output voltage reached
 192 the steady state regime, showing a small ripple since the signal is almost constant.

193 Fig. 8 shows the DC power P_{DC} as a function of the resistive load for different rectifier
 194 topologies and diode references. The shape of the $P_{DC}(R_L)$ curve is very similar to the case
 195 without rectifying circuit as it presents a maximum for a given value of load called R_L^{DC} . The

Table 2: Summary of the computed and measured optimal load and power at optimal load for different topologies of rectifier and diodes references.

Diode reference	Fullwave rectifier				Voltage doubler			
	Computation		Measurement		Computation		Measurement	
	R_L^{DC}	P_{DC}^{max}	R_L^{DC}	P_{DC}^{max}	R_L^{DC}	P_{DC}^{max}	R_L^{DC}	P_{DC}^{max}
1N4148	2.84 M Ω	2.22 μ W	2.94 M Ω	2.11 μ W	12.3 M Ω	2.21 μ W	11.1 M Ω	2.23 μ W
RB751S40	2.81 M Ω	2.37 μ W	2.83 M Ω	2.49 μ W	12.2 M Ω	2.25 μ W	10.9 M Ω	2.25 μ W
1PS79SB30	2.74 M Ω	2.05 μ W	2.70 M Ω	2.30 μ W	11.5 M Ω	1.79 μ W	11.2 M Ω	1.93 μ W
1PS76SB10	2.53 M Ω	0.46 μ W	2.49 M Ω	1.42 μ W	9.8 M Ω	0.28 μ W	9.0 M Ω	0.99 μ W

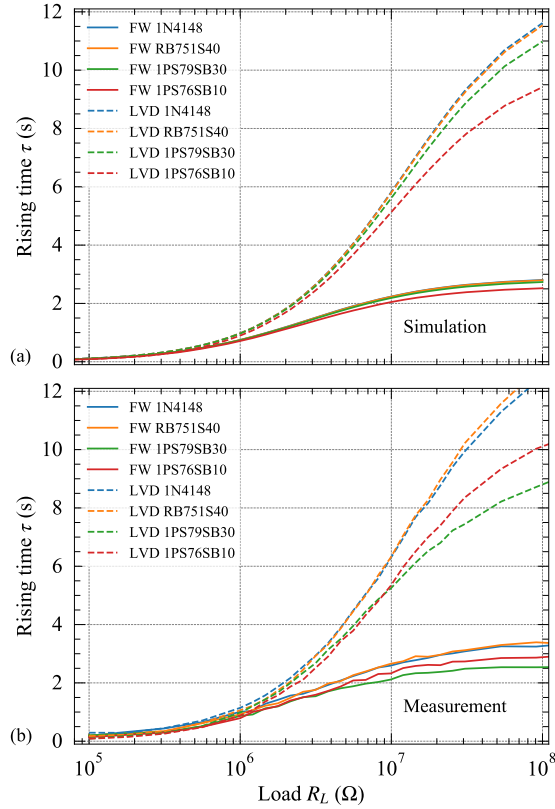

Figure 9: Rising time as a function of the resistive load for different rectifier topologies and diode references (a) simulation (b) experiment. FW stands for fullwave rectifier, full lines, and LVD stands for Latour voltage doubler, dashed-dotted lines.

196 optimal load and the power at this load are summarized in table 2. For both topologies of recti-
 197 fier, a higher power is obtained when using the diode with the smaller leakage current. Except
 198 the high leakage current diode (1PS76SB10), the maximum power and optimal load are similar
 199 for all other types of diodes and are quite well predicted by the simulation. This shows, in the
 200 case of adapted diodes, that the topology of the rectifier is not critical in order to get the maxi-
 201 mum power. The optimal load for the fullwave rectifier is higher than the optimal load without
 202 rectifier, 2.74 MΩ instead of 1.72 MΩ, but lower than for the voltage doubler (10.5 MΩ). This
 203 value of the optimal load for the fullwave bridge is consistent with the theoretical value given
 204 by Badel *et al*¹⁵:

$$R_{L-FW}^{DC} = \frac{\pi}{2C_{int}\omega_0} \quad (7)$$

205 which gives a numerical value of 2.86 MΩ. This indicates the topology of the rectifier largely
 206 modifies the optimal load. The maximum power, 2.49 μW for the fullwave rectifier using
 207 RB751S40 diodes, has to be compared to the maximum power without rectifier (4.29 μW) which
 208 gives a efficiency of 57 % even for the “best” rectifier. For the “worst” rectifier, the voltage dou-
 209 bler using 1PS76SB10 diodes, the efficiency is 23 % which corresponds to a 2.5 factor on the
 210 maximum power value, which is far from being negligible.

211 When the capacitor is initially discharged, it takes some time to the PG to charge the ca-
 212 pacitor to the final voltage. The Fig. 9 shows the rising time as a function of the resistive load
 213 for different topologies of the rectifier. For a given type of rectifier, the choices of the diode
 214 does not influence significantly the rising time. The rising time increases with the load value
 215 because the final voltage also increases. This comes from the fact that, to charge the capacitor
 216 using a generator with a capacitve internal impedance, at each alternance only a small fraction
 217 of the open circuit voltage is transmitted to the storage capacitor²⁴. As a consequence, to reach
 218 the steady state voltage, an high number of period is necessary. The difference between the two
 219 topologies of rectifier is clear: the rising time is approximately 4 times higher for the voltage
 220 doubler. Results given by both simulation and experience are very close to each other.

221 3.3 Influence of the internal impedance of the PG

222 Depending on the PG characteristics, namely the dielectric permittivity or thickness of the ac-
 223 tive material, the surface or shape of the electrodes, the internal impedance value may change
 224 drastically. For example, in the case of ZnO-NW or AlN based generators^{25,10}, the internal
 225 capacitance value is relatively small compared to PZT based generators²⁶.

226 Fig. 10a shows the average voltage as a function of the resistive load, for different values of
 227 the internal capacitance of the PG, for the fullwave rectifier using 1N4148 diodes. The extrac-
 228 tion of the average voltage has been made using the same procedure described in section 3.2.
 229 For values of the internal impedance from 10⁻⁸ F to 10⁻⁶ F, the same shape is obtained. For low
 230 resistive load value the voltage is small, then the voltage starts to increase when the resistive
 231 load is closed to the optimal load and finally the average voltage tends a limit which corre-
 232 sponds to the open circuit voltage. For a capacitance value of 10⁻⁹ F, the shape is similar but
 233 the average voltage seems to tend to a lower value than the open circuit voltage. This may be
 234 explained by the leakage current of the diodes, even very low but not negligible compared to
 235 the current provided by the PG.

236 Using the average voltage, the power of the DC component can be computed (Fig. 10b).
 237 When the internal impedance increases, (i) the maximum power increases and (ii) the optimal
 238 load decreases which is consistent with equations (2) and (7) respectively.

239 In order to see the effect of the diodes, simulations have been performed for different diodes,
 240 for the fullwave rectifier and as a function of the resistive load, over a range of internal capaci-
 241 tance from 10⁻⁹ F to 10⁻⁶ F. The power of the DC component has been extracted as a function

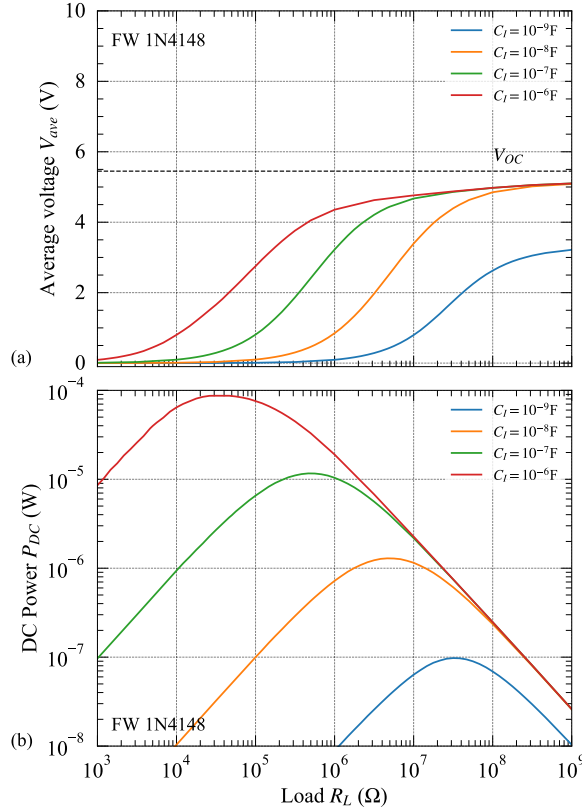

Figure 10: (a) Average voltage and (b) power of the DC component as a function of the resistive load, for different values of the internal capacitance of the PG.

242 of the resistive load using the procedure described previously. The maximum of this curve and
 243 the corresponding optimal load can thus be obtained for each value of the internal capacitance.
 244 Normalization of the maximum power has been done by dividing the maximum of the $P_{DC}(R_L)$
 245 curve by the maximum AC power given by equation (2). Normalized maximum power and
 246 optimal load are presented Fig. 11.

247 Depending on the diode reference, corresponding to a given threshold voltage/leakage cur-
 248 rent couple, the normalized power shows a maximum for a different value of the internal capaci-
 249 tance (Fig. 11a). For low values of the internal capacitance, 10^{-9} F for example (signifying a PG
 250 which cannot provide a high level of current), the best choice for the diode is to have the small-
 251 est leakage current as possible even if the threshold voltage is high (for example the 1N4148
 252 diode). For this low value of internal capacitance, 1PS79SB30 and 1PS76SB10 present a so
 253 high leakage current that the harvested power is almost null. On the other hand, for a relatively
 254 high value of the internal capacitance, 10^{-6} F for example (signifying a PG which can provide
 255 a larger amount of current), the best choice is to have the smallest threshold voltage as possi-
 256 ble even if the leakage current is high (for example the 1PS76SB10 diode). This shows that,
 257 depending of the internal capacitance, one parameter of the diode, leakage current or threshold
 258 voltage, is the dominant limiting factor. The choice of the diode is thus critical and depends on
 259 the internal capacitance of the PG.

260 The optimal load, for which the maximum power is obtained, is reported Fig. 11b. The
 261 optimal load decreases when the internal capacitance increases and almost no difference is
 262 visible when the diode changes. The discrepancy at low values of the internal capacitance,
 263 for example in the range $[10^{-9}$ F, 10^{-8} F] for the 1PS76SB10 diode, mainly comes from the
 264 very low value of the power (Fig. 11a) and thus no clear maximum of power is visible, and
 265 the corresponding optimal load is not following the same tendency as with the other diodes.

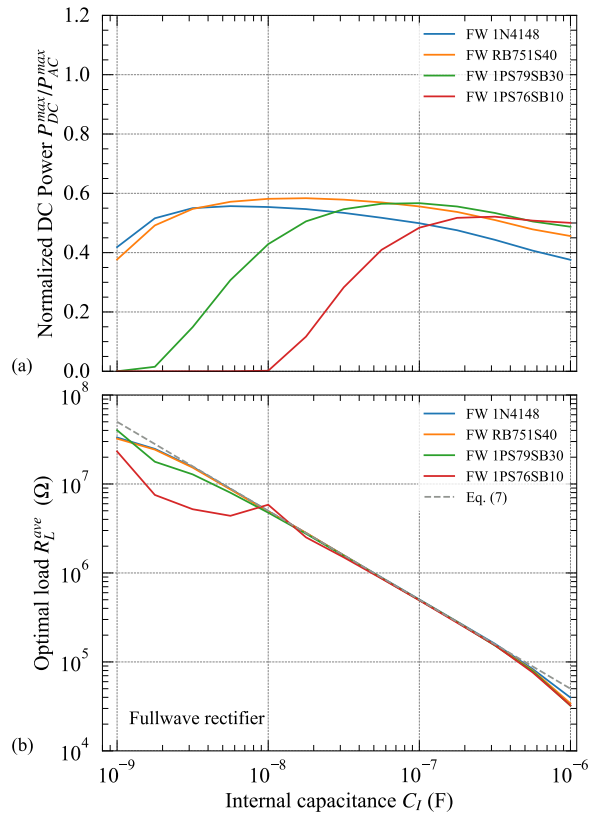

Figure 11: (a) Normalized maximum power and (b) optimal load as a function of the internal capacitance of the PG for the fullwave rectifier and the different diodes. Dashed line corresponds to the optimal load computed using (7).

266 Nevertheless, for this range of internal capacitance, low leakage diodes (1N4148 or RB751S40)
267 would be preferable since the power is higher and in that case, the optimal load is correctly
268 predicted.

269 **4 Conclusion**

270 In this paper, different topologies of rectifier, fullwave rectifier and voltage doubler, using differ-
271 ent diode references, having various leakage currents and threshold voltages, have been studied.
272 The rectifiers have been connected to a piezoelectric generator having a capacitive internal im-
273 pedance. The theoretical study has been confirmed by experimental tests carried out with a PZT
274 buzzer submitted to a controlled force. We show that the topology of the rectifier slightly influ-
275 ences the optimal load, at which the average power is maximal, but has only a small influence
276 on the optimal power value. The choice of the topology is thus mainly dependent on the output
277 voltage needed for the application.

278 Concerning the effect of the diode reference, the leakage current and threshold voltage are
279 linked to each other, the lower the leakage current, higher the threshold voltage. In our case, the
280 leakage current is the most limiting factor and must be as low as possible. On the contrary, the
281 threshold voltage is less critical. Between the highest and lowest efficient AC/DC converter, a
282 2.5 factor is observed highlighting the importance of minimizing the leakage current.

283 We also show the internal impedance of the PG must be taken into account for the choice of
284 the diode. Low threshold voltage diodes are more appropriate to high internal capacitance and
285 low leakage current are preferable for low internal capacitance value.

286 **Author contributions**

287 K.N. and G.P.V designed the experiments. K.N. performed the simulations, measurements, data
288 analysis and did the drafting of the manuscript. G.P.V. and D.A. did critical revisions of the
289 manuscript and funding acquisition. All authors have read and approved the final manuscript.

290 **Data availability**

291 The data that support the findings of this study are available from the corresponding author upon
292 reasonable request.

293 **Acknowledgement**

294 This project has received funding from the ECSEL JU under grant agreement N°692482. This
295 JU receives support from the European Union's H2020 research and innovation program and
296 France, Netherlands, Denmark, Belgium, Germany, Czek Republic, Spain. The Authors are
297 also grateful for the supports from Region Centre (MEPS project 2015-2018) and National
298 Research Agency (ANR-14-CE08-0010-01). The authors would like to thank Henrik Zessin,
299 Vesa-Pekka Torvinen and Peter Spies, from Fraunhofer Institute for Integrated Circuits IIS, for
300 providing the rectifiers.

301 **Conflict of interest**

302 The authors declare no conflict of interest

References

- [1] G. Zhu, A. C. Wang, Y. Liu, Y. Zhou, Z. L. Wang, Functional electrical stimulation by nanogenerator with 58 V output voltage, *Nano Letters* 12 (6) (2012) 3086–3090. doi:10.1021/nl300972f.
- [2] C. Opoku, A. S. Dahiya, F. Cayrel, G. Poulin-Vittrant, D. Alquier, N. Camara, Fabrication of field-effect transistors and functional nanogenerators using hydrothermally grown ZnO nanowires, *RSC Adv.* 5 (2015) 69925–69931. doi:10.1039/C5RA11450K.
- [3] R. Tao, M. Parmar, G. Ardila, P. Oliveira, D. Marques, L. Montès, M. Mouis, Performance of ZnO based piezo-generators under controlled compression, *Semiconductor Science and Technology* 32 (6) (2017) 064003. doi:10.1088/1361-6641/aa691f.
- [4] N. Gogneau, N. Jamond, P. Chrétien, F. Houzé, E. Lefeuvre, M. Tchernycheva, From single III-nitride nanowires to piezoelectric generators: New route for powering nomad electronics, *Semiconductor Science and Technology* 31 (10) (2016) 103002. doi:10.1088/0268-1242/31/10/103002.
- [5] S. Xu, B. J. Hansen, Z. L. Wang, Piezoelectric-nanowire-enabled power source for driving wireless microelectronics, *Nature Communications* (2010) 93doi:10.1038/ncomms1098.
- [6] Y. Hu, Y. Zhang, C. Xu, L. Lin, R. L. Snyder, Z. L. Wang, Self-powered system with wireless data transmission, *Nano Letters* 11 (6) (2011) 2572–2577. doi:10.1021/nl201505c.
- [7] S. Roundy, P. K. Wright, A piezoelectric vibration based generator for wireless electronics, *Smart Materials and Structures* 13 (5) (2004) 1131. doi:10.1088/0964-1726/13/5/018.
- [8] Z. Lin, J. Chen, X. Li, Z. Zhou, K. Meng, W. Wei, J. Yang, Z. L. Wang, Triboelectric nanogenerator enabled body sensor network for self-powered human heart-rate monitoring, *ACS Nano* 11 (9) (2017) 8830–8837. doi:10.1021/acsnano.7b02975.
- [9] S. Xu, Y. Qin, C. Xu, Y. Wei, R. Yang, Z. L. Wang, Self-powered nanowire devices, *Nature Nanotechnology* 5 (2010) 366. doi:10.1038/nnano.2010.46.
- [10] M. Marzencki, Y. Ammar, S. Basrou, Integrated power harvesting system including a MEMS generator and a power management circuit, *Sensors and Actuators A: Physical* 145-146 (Supplement C) (2008) 363 – 370. doi:https://doi.org/10.1016/j.sna.2007.10.073.
- [11] P. Miribel-Català, J. Colomer-Fararons, J. L. Brinquis, J. López-Sánchez, Self-powered adaptive circuit sampling for a piezoelectric harvester, in: *Design of Circuits and Integrated Systems*, IEEE, 2014, pp. 1–6. doi:10.1109/DCIS.2014.7035581.
- [12] D. Zhu, S. P. Beeby, M. J. Tudor, N. R. Harris, A credit card sized self powered smart sensor node, *Sensors and Actuators A: Physical* 169 (2) (2011) 317 – 325. doi:https://doi.org/10.1016/j.sna.2011.01.015.
- [13] H. Wei, D. Cui, J. Ma, L. Chu, X. Zhao, H. Song, H. Liu, T. Liu, N. Wang, Z. Guo, Energy conversion technologies towards self-powered electrochemical energy storage systems: the state of the art and perspectives, *J. Mater. Chem. A* 5 (2017) 1873–1894. doi:10.1039/C6TA09726J.

- 345 [14] M. Balato, L. Costanzo, A. L. Schiavo], M. Vitelli, Optimization of both perturb & observe
346 and open circuit voltage MPPT techniques for resonant piezoelectric vibration harvesters
347 feeding bridge rectifiers, *Sensors and Actuators A: Physical* 278 (2018) 85 – 97. doi:
348 <https://doi.org/10.1016/j.sna.2018.05.017>.
- 349 [15] A. Badel, D. Guyomar, E. Lefeuvre, C. Richard, Piezoelectric energy harvesting using
350 a synchronized switch technique, *Journal of Intelligent Material Systems and Structures*
351 17 (8-9) (2006) 831–839. doi:10.1177/1045389X06057533.
- 352 [16] D. Guyomar, A. Badel, E. Lefeuvre, C. Richard, Toward energy harvesting using ac-
353 tive materials and conversion improvement by nonlinear processing, *IEEE Transactions*
354 *on Ultrasonics, Ferroelectrics, and Frequency Control* 52 (4) (2005) 584–595. doi:
355 [10.1109/TUFFC.2005.1428041](https://doi.org/10.1109/TUFFC.2005.1428041).
- 356 [17] R. Srinivasan, U. Mangalanathan, U. Gandhi, L. R. Karlmarx, Bridgeless active rectifier
357 for piezoelectric energy harvesting, *IET Circuits, Devices & Systems* 13 (7) (2019) 1078–
358 1085. doi:10.1049/iet-cds.2018.5576.
- 359 [18] C.-Y. Hsieh, M. Moallem, F. Golnaraghi, Bridgeless converter with input resistance con-
360 trol for low-power energy harvesting applications, *IET Power Electronics* 8 (5) (2015)
361 822–830. doi:10.1049/iet-pel.2014.0283.
- 362 [19] A. S. Dahiya, F. Morini, S. Boubenia, C. Justeau, K. Nadaud, K. P. Rajeev, D. Alquier,
363 G. Poulin-Vittrant, Zinc oxide nanowire-parylene nanocomposite based stretchable piezo-
364 electric nanogenerators for self-powered wearable electronics, *Journal of Physics: Con-*
365 *ference Series* 1052 (2018) 012028. doi:10.1088/1742-6596/1052/1/012028.
- 366 [20] Diode incorporated, <https://www.diodes.com/design/tools/spice-models/>, ac-
367 cessed: 2020-04-04.
- 368 [21] Xyce electronic simulator™, <https://xyce.sandia.gov/>, accessed: 2020-04-04.
- 369 [22] K. Nadaud, G. Poulin-Vittrant, D. Alquier, Effect of the excitation waveform on the av-
370 erage power and peak power delivered by a piezoelectric generator, *Mechanical Systems*
371 *and Signal Processing* 133 (2019) 106278. doi:10.1016/j.ymsp.2019.106278.
- 372 [23] Z. Yang, L. Tang, L. Yu, K. Tao, K. Aw, Modelling and analysis of an out-of-plane electret-
373 based vibration energy harvester with AC and DC circuits, *Mechanical Systems and Signal*
374 *Processing* 140 (2020) 106660. doi:10.1016/j.ymsp.2020.106660.
- 375 [24] M. J. Kraśny, C. R. Bowen, C. Michel, J. T. Taylor, Transient analysis of a current-driven
376 full wave AC/DC converter for indirect characterization of piezoelectric devices during
377 energy harvesting, *Energy Technology* 8 (3) (2020) 1901317. doi:10.1002/ente.
378 201901317.
- 379 [25] K. Nadaud, F. Morini, A. S. Dahiya, C. Justeau, S. Boubenia, K. P. Rajeev, D. Alquier,
380 G. Poulin-Vittrant, Double buffer circuit for the characterization of piezoelectric nano-
381 generators based on ZnO nanowires, *Applied Physics Letters* 112 (2018) 063903. doi:
382 [10.1063/1.5018145](https://doi.org/10.1063/1.5018145).
- 383 [26] D. Isarakorn, D. Briand, P. Janphuang, A. Sambri, S. Gariglio, J.-M. Triscone, F. Guy,
384 J. W. Reiner, C. H. Ahn, N. F. de Rooij, The realization and performance of vibration
385 energy harvesting MEMS devices based on an epitaxial piezoelectric thin film, *Smart Ma-*
386 *terials and Structures* 20 (2) (2011) 025015. doi:10.1088/0964-1726/20/2/025015.